

Video Version / Versión Video



· C I A P I R I · SILLÓN / CHAIR

| 1 Cushion included | Includo 1cojín

ASSEMBLY INSTRUCTIONS INSTRUCCIONES DE ENSAMBLE

www.plasticosmq.com.co

/ Assembly Parts / Piezas de Ensamble

Required Tool / Herramienta Requerida
*Included / Includa

Screw Wrench
/ LLave para tornillos



x1

Includes 1
replacement screw
Incluye 1 tornillo
de repuesto

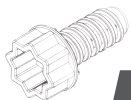

x1

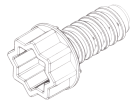

x12



x6

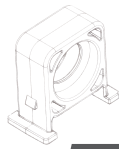

x4



1 x1



2 x1



3 x1



4 x1



RA x1



RA-CO x1



LA x1



LA-CO x1

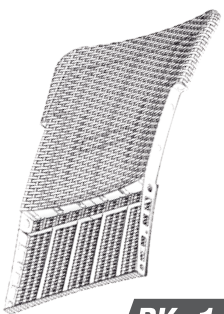

BK x1

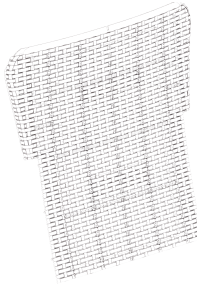

BK-CO x1



SE x1

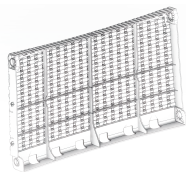

FB x1

STEP
/ PASO

1

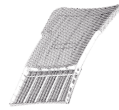

BK x1



SE x1

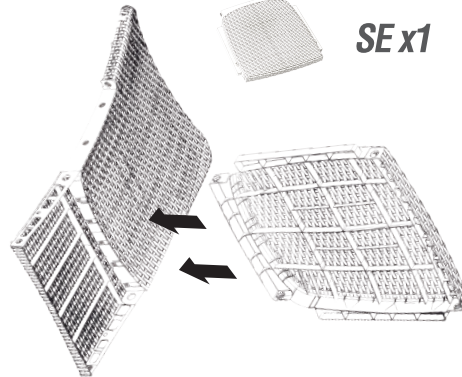

STEP
/ PASO

2

FB x1

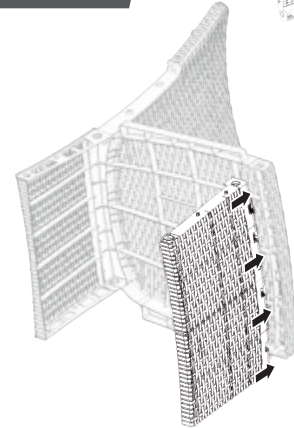

STEP
/ PASO

3



x1



x3



x2

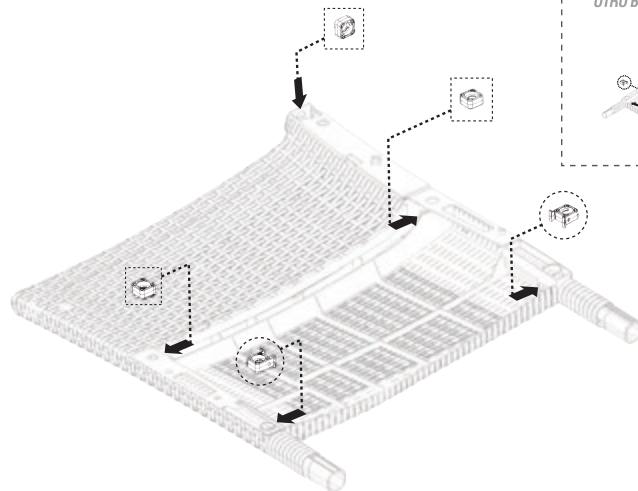

REPEAT THIS STEP WITH THE
ANOTHER ARM OF THE CHAIR
REPITE ESTE PASO CON EL
OTRO BRAZO DEL SILLÓN

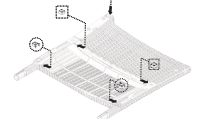

STEP / PASO

4

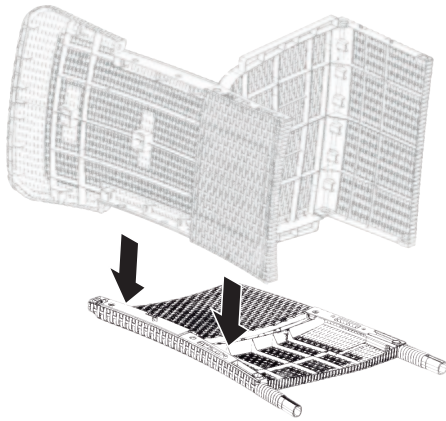

STEP / PASO

5

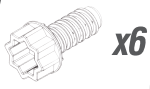

Use the included tool to secure the screws
Utilice la herramienta incluida para asegurar los tornillos

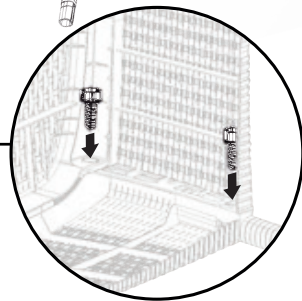
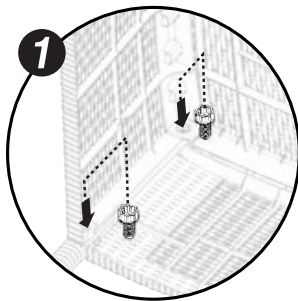
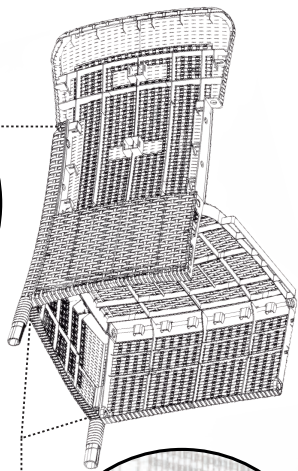
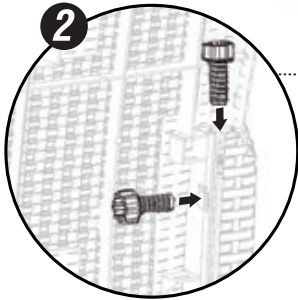

STEP / PASO

6

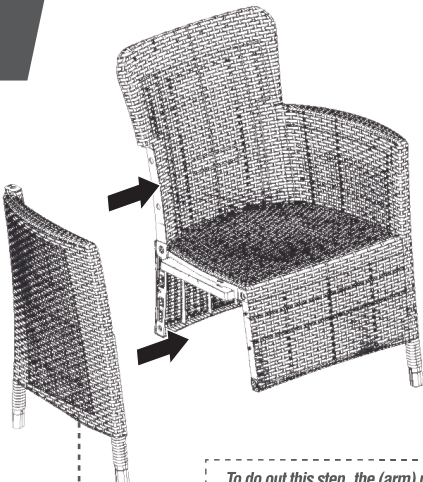

To do out this step, the (arm) piece must be pre-assembled from step 3
Para realizar este paso la pieza (brazo) debe estar pre-ensamblada desde el paso 3

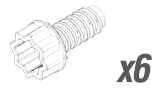

STEP / PASO

7

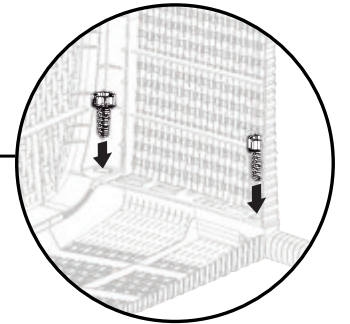
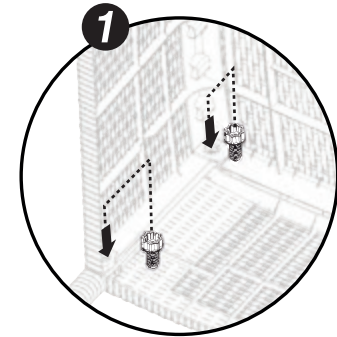
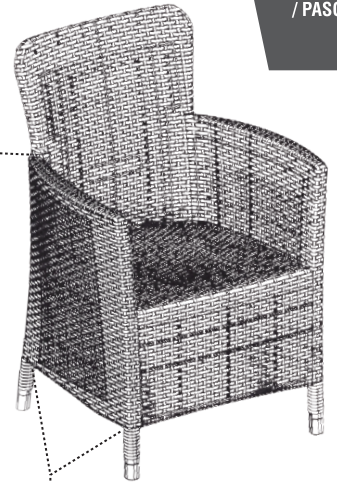
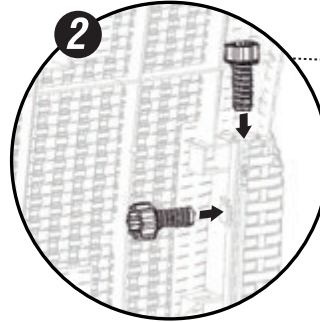

STEP / PASO

8

click

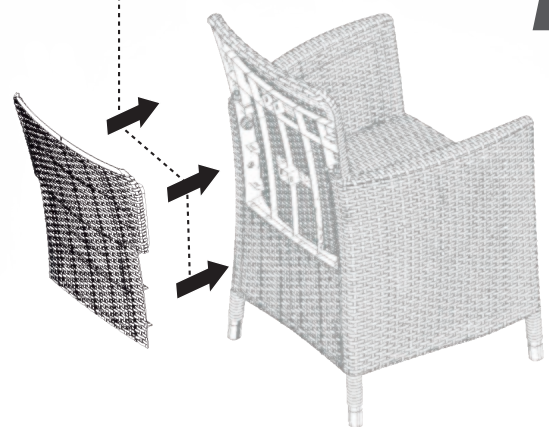

STEP / PASO

6

Check the identification number
Verifique el número de identificación

1-2-3-4



STEP / PASO

9

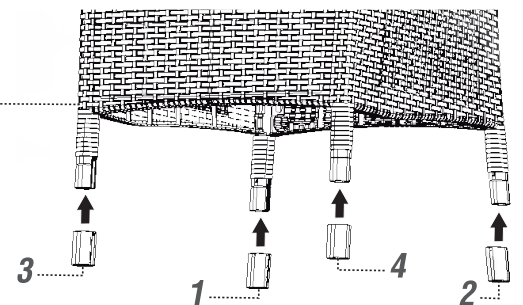
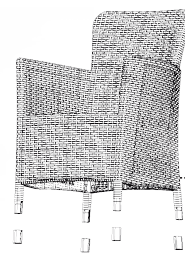



ASSEMBLY INSTRUCTIONS INSTRUCCIONES DE ENSAMBLE

MADEIRA TABLE / RECTANGULAR MESA MADEIRA



/ Assembly Parts / Piezas de Ensamble

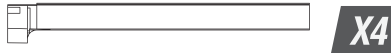

X4

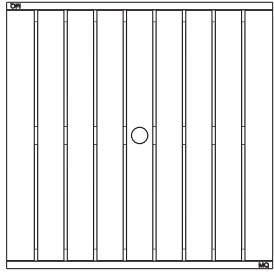

X2

Bristol screw
Tornillos cabeza bristol



X2

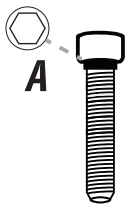

A

X16



B

X16



C

X16

Cross Screws
Tornillos de estrella

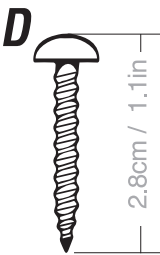

2.8cm / 1.1in

X4



4cm / 1.57in

X8

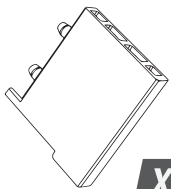

X2

L Key
Llave bristol



X1

Double hex key
Llave hexagonal doble



X1

Place side by side the table ends with perforations
Enfrentar los extremos de la mesa con perforaciones

1

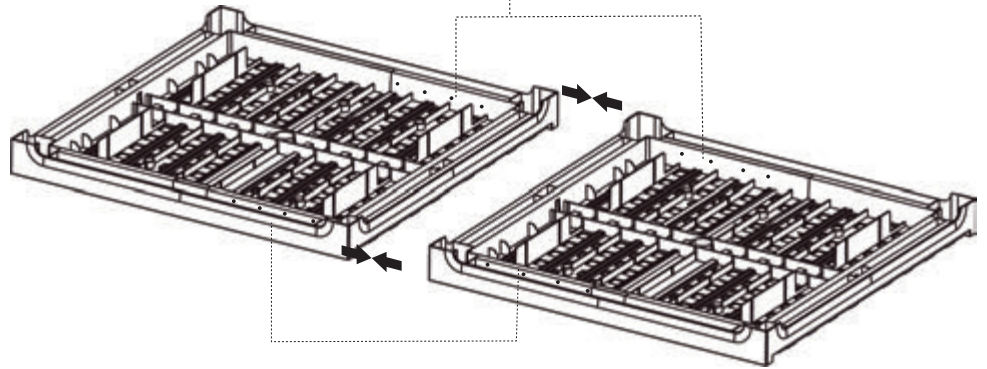

x2 Repeat this step with both
metal plates and joints
Repita este paso con las dos
platinas metálicas y uniones

2

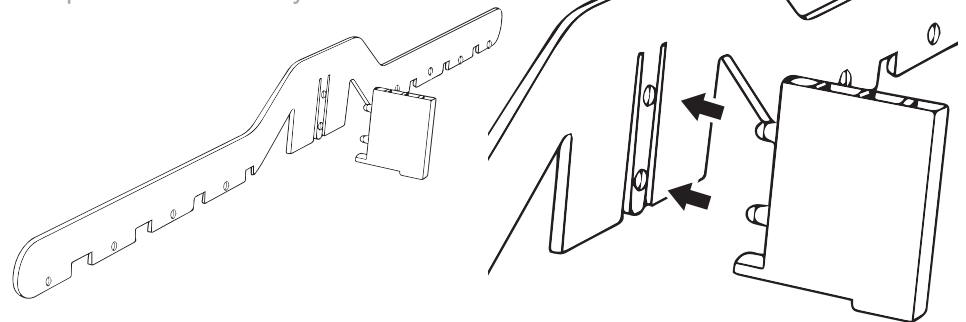

Be sure to align the metal plates
with covers and holes on the sides of
the pieces for later screws installation.

Asegure de alinear las platinas
metálicas con las cubiertas y los
orificios en los laterales de la misma
para posteriormente instalar
los tornillos.

3

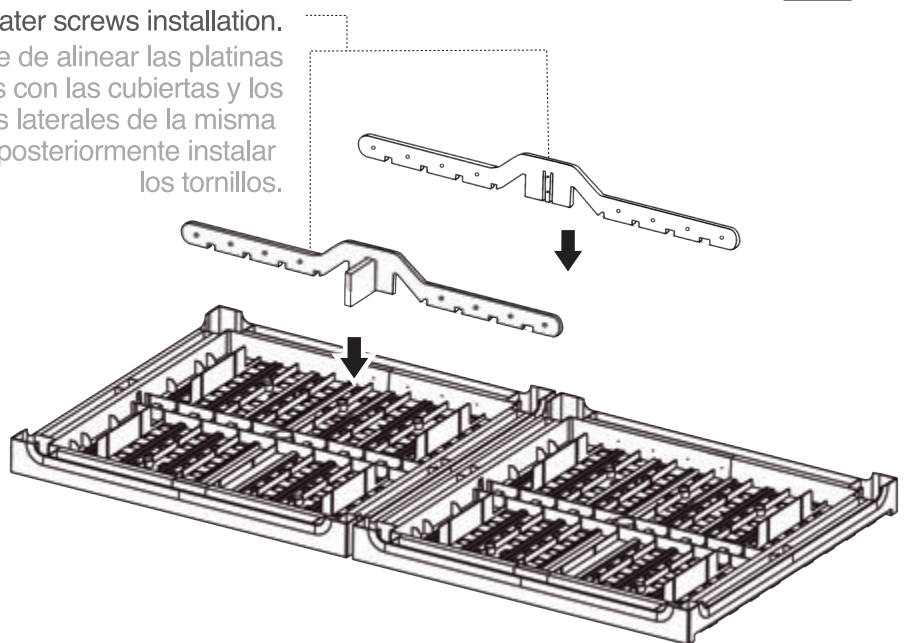

4

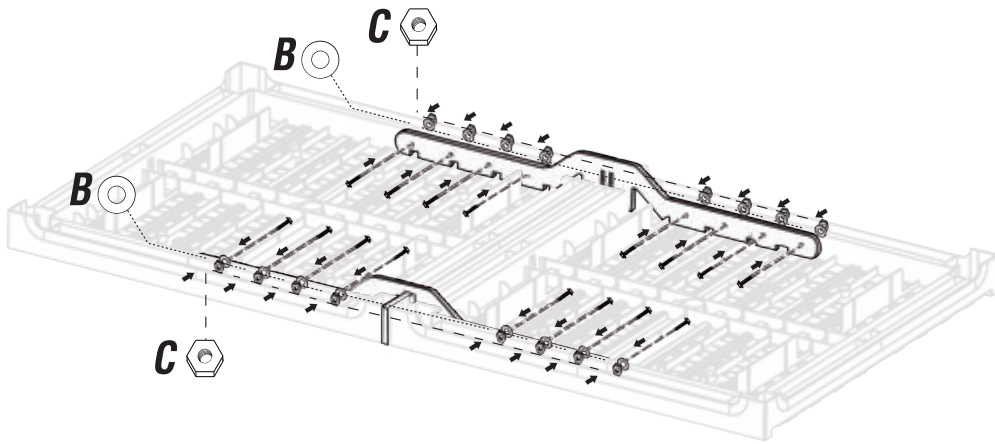

Secure the screws with
the included tools
Utilice la herramienta incluida
para asegurar los tornillos



5

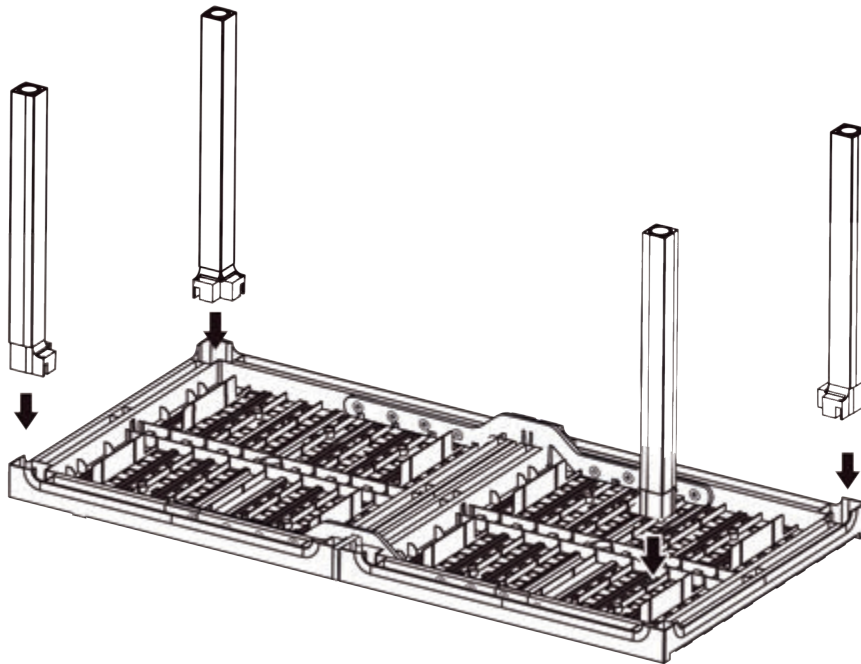

6

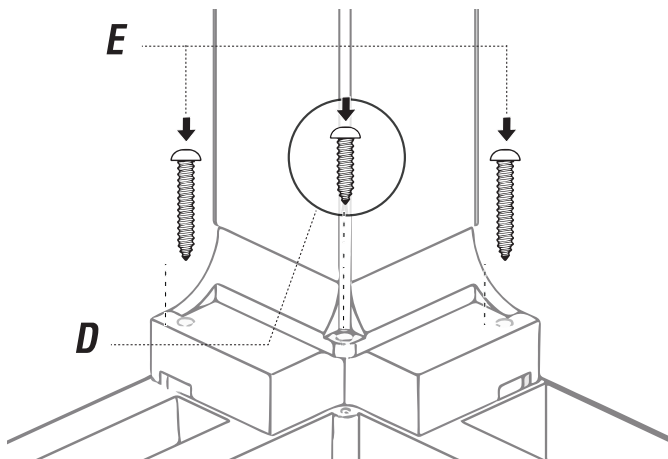

VIEW ASSEMBLY VIDEO | VER VIDEO DE ENSAMBLE



LINE / LINEA
MADEIRA

IMPORTANT: Please contact Customer Service if you have any problems or discover any missing parts.
IMPORTANTE: Sírvase contactar con nuestro Servicio al Cliente por cualquier problema o pieza que pudiera faltar. www.plasticosmq.com.co