



SALA COMFORT /
COMFORT FURNITURE SET

·C|Λ|P|R|I·

ASSEMBLY INSTRUCTIONS

INSTRUCCIONES DE ENSAMBLE

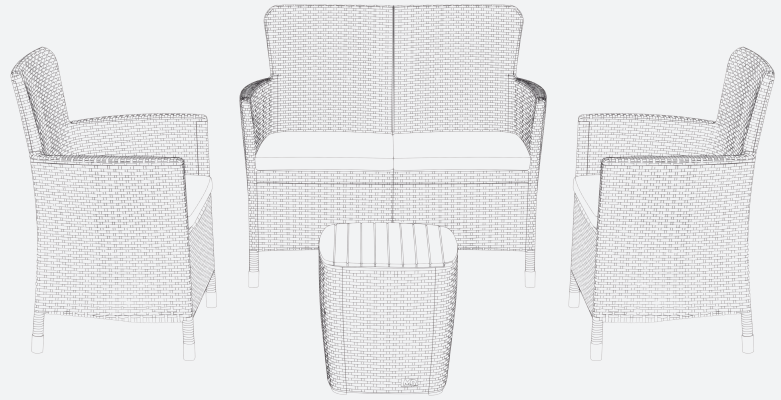

www.plasticosmq.com.co

/ Assembly Parts / Piezas de Ensamble

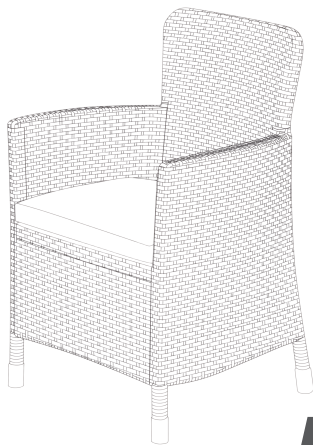

x2

·C|Λ|P|R|I·
SILLÓN / CHAIR

2 Cushions included
Incluidos 2 cojines

Video Version / Versión Video



Required Tool / Herramienta Requerida
*Included / Incluida

Screw Wrench
/ LLave para tornillos



x1

Includes 2
replacement screws
Incluye 2 tornillos
de repuesto

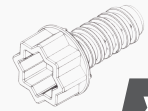

x2

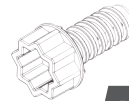

x24



x12



x8

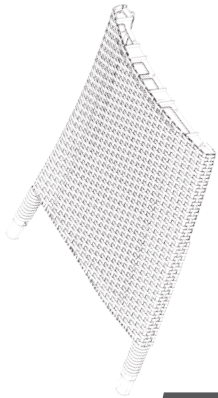

RA x2

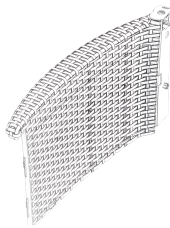

RA-CO x2

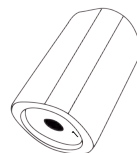

1 x2

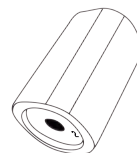

2 x2

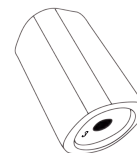

3 x2

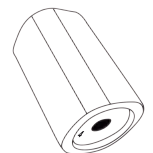

4 x2

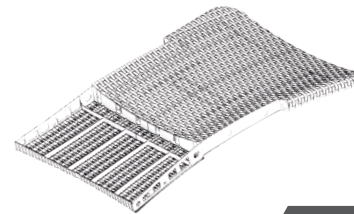

BK x2



BK-CO x2



LA x2

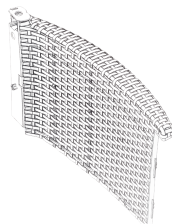

LA-CO x2

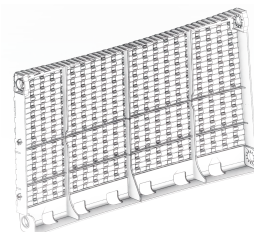

FB x2



SE x2

STEP / PASO

1

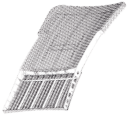

BK x1



SE x1

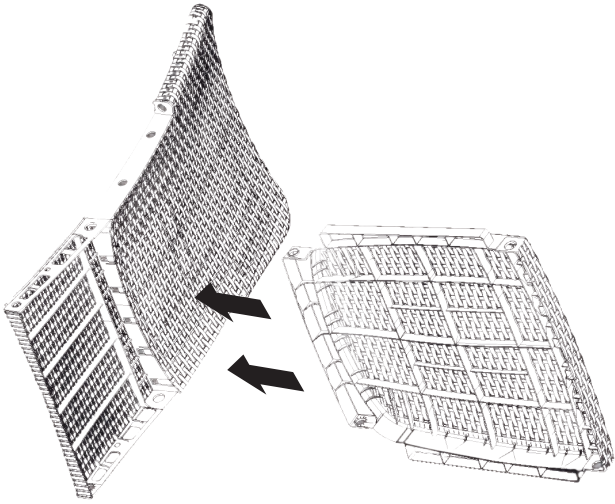

STEP / PASO

2



FB x1

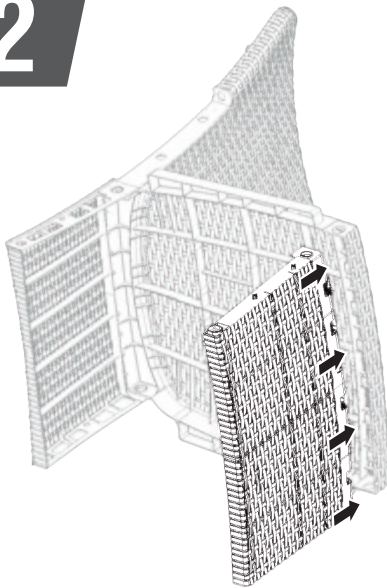

STEP / PASO

3



x1



x3



x2

REPEAT THIS STEP WITH THE ANOTHER ARM OF THE CHAIR
REPITE ESTE PASO CON EL OTRO BRAZO DEL SILLÓN

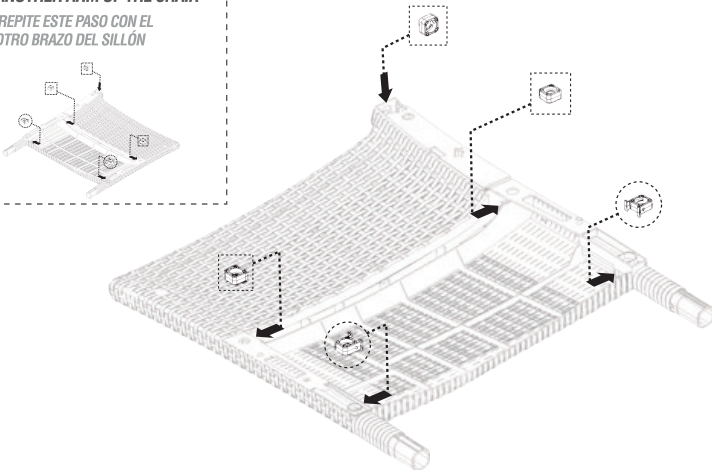

STEP / PASO

4



x1

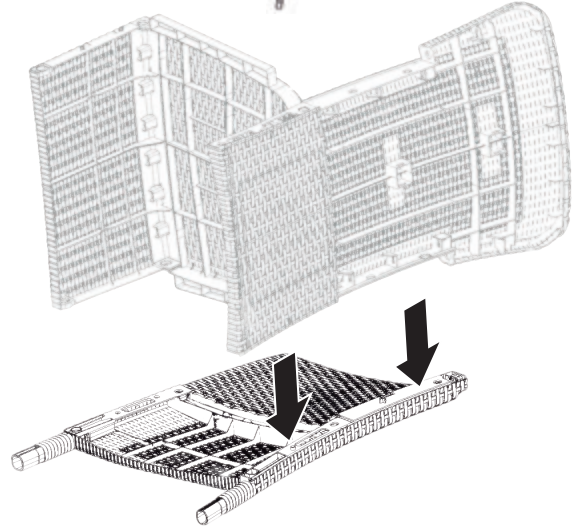

STEP / PASO

5

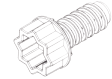
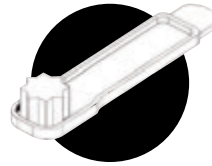

x6

Use the included tool to secure the screws
Utilice la herramienta incluida para asegurar los tornillos

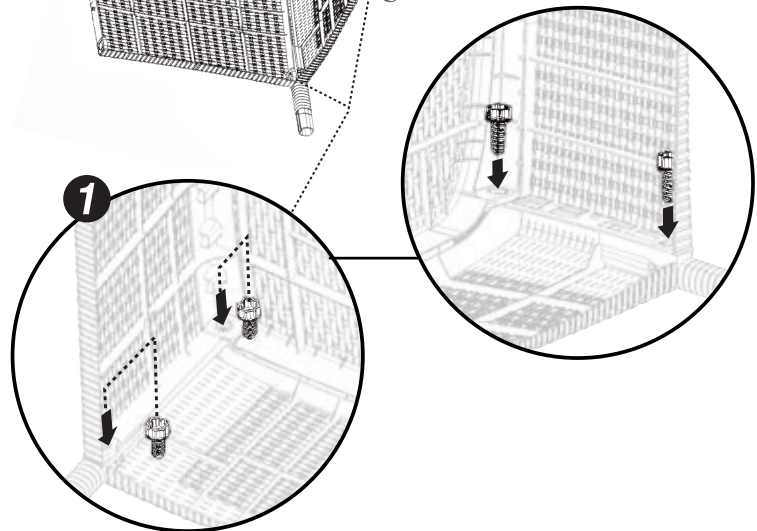
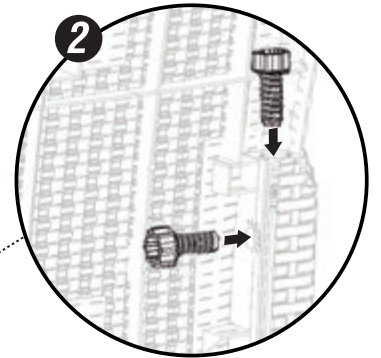
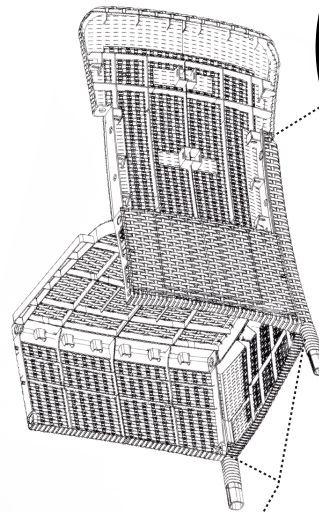

STEP / PASO **6**

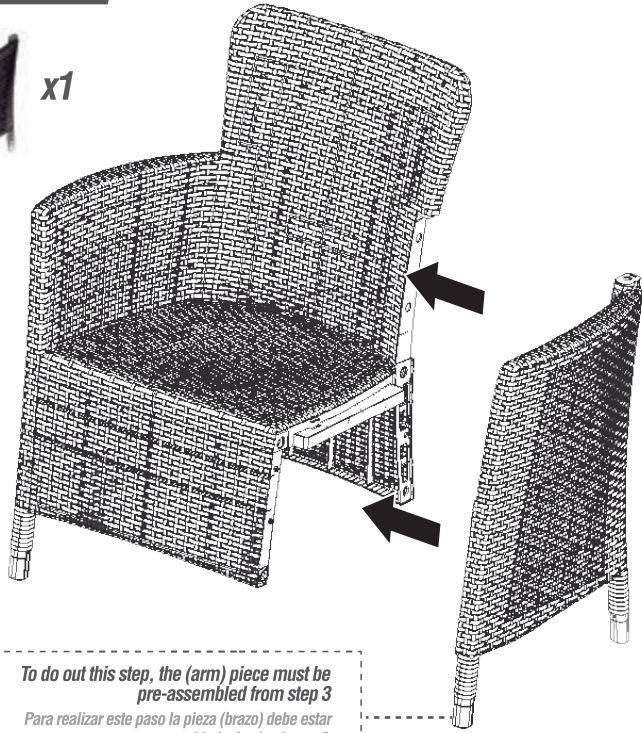

To do out this step, the (arm) piece must be pre-assembled from step 3
Para realizar este paso la pieza (brazo) debe estar pre-ensamblada desde el paso 3

STEP / PASO **8**

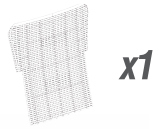

click

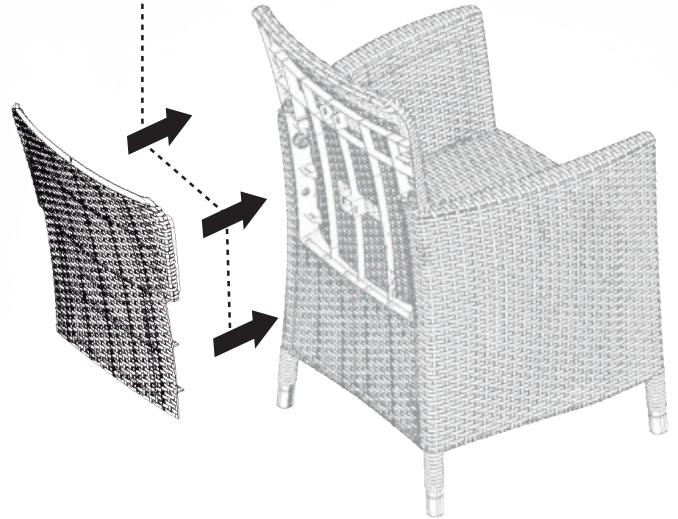

STEP / PASO **7**

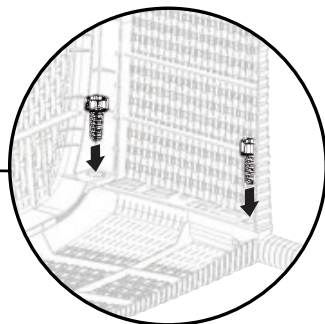
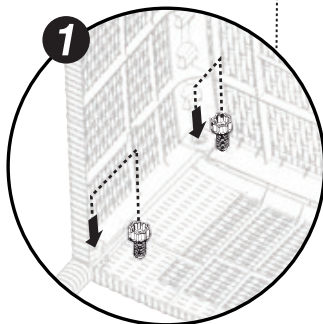
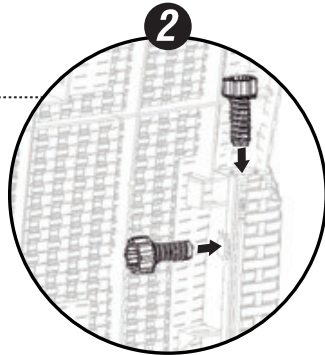
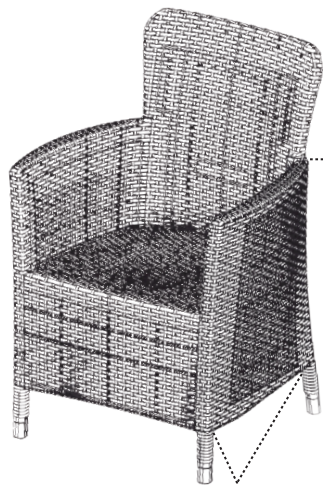
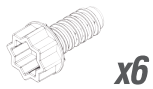

Check the identification number
Verifique el número de identificación

1-2-3-4



STEP / PASO **9**

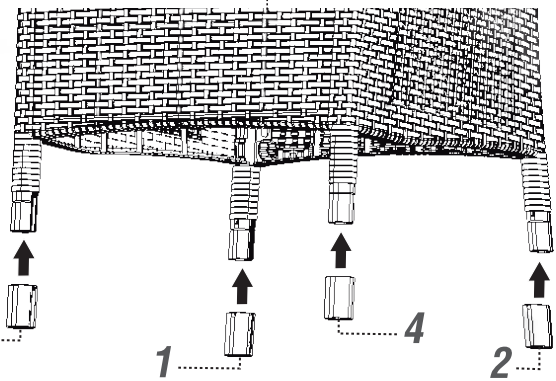
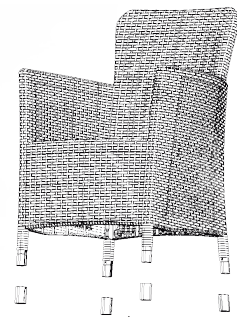



x1

Video Version / Versión Video



CIAPIRI

SOFÁ 2 PUESTOS / TWO-SEAT SOFA

| 2 Cushions included | Includo 2 cojín

ASSEMBLY INSTRUCTIONS

INSTRUCCIONES DE ENSAMBLE

www.plasticosmq.com.co

/ Assembly Parts / Piezas de Ensamble

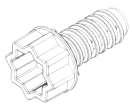

x22



x16

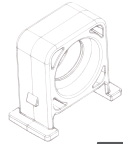

x4

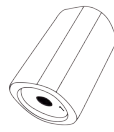

1 x1

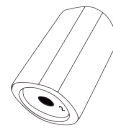

2 x1

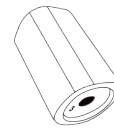

3 x1

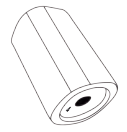

4 x1

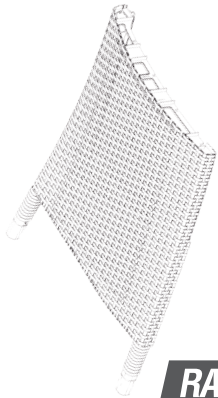

RA x1

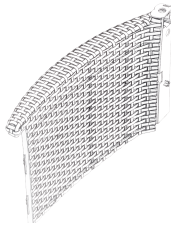

RA-CO x1

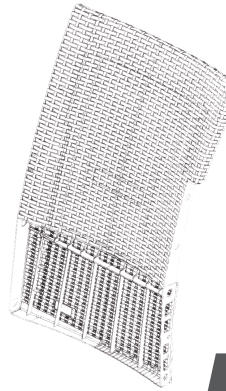

LBK x1

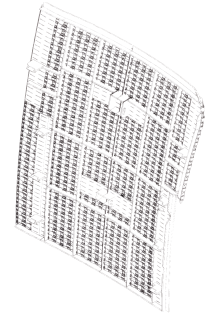

LBK-CO x1

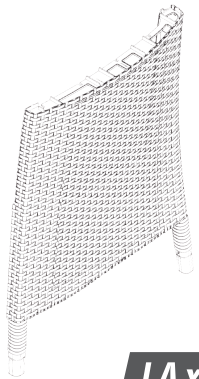

LA x1

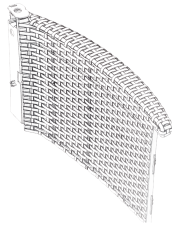

LA-CO x1

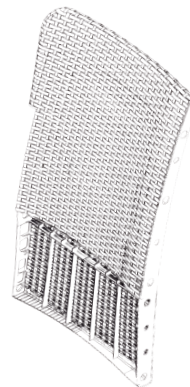

RBK x1

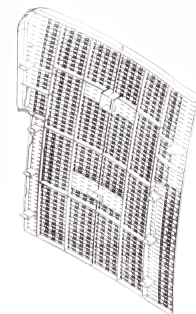

RBK-CO x1

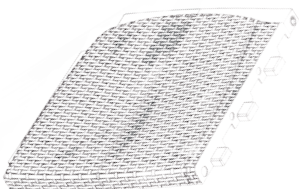

RSE x1

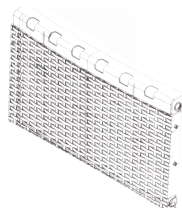

FB-RA x1

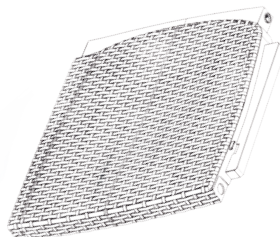

LSE x1

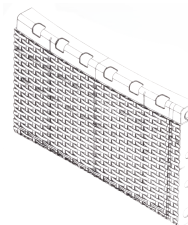

FB-LA x1

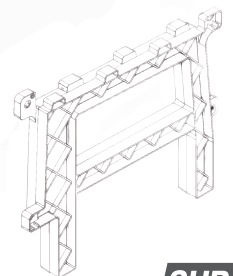

SUP x1

STEP
/ PASO

1



RBK x1

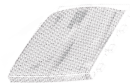

RSE x1



LBK x1



LSE x1

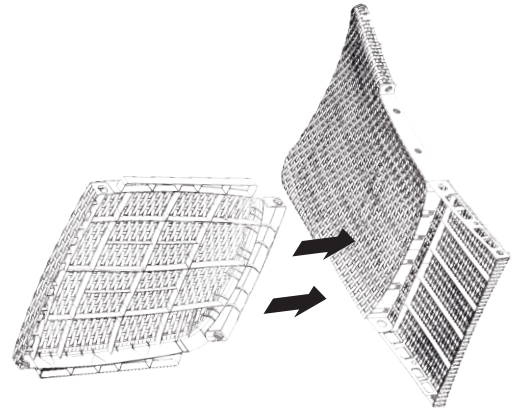
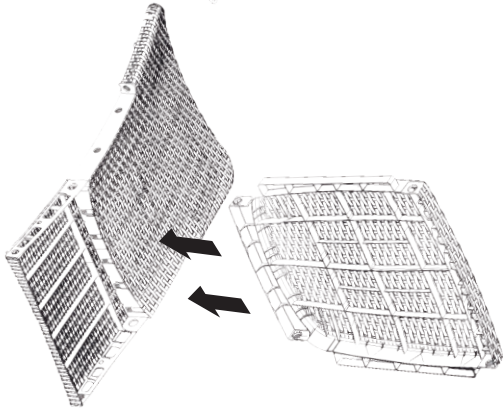

STEP
/ PASO

2

FB-RA x1

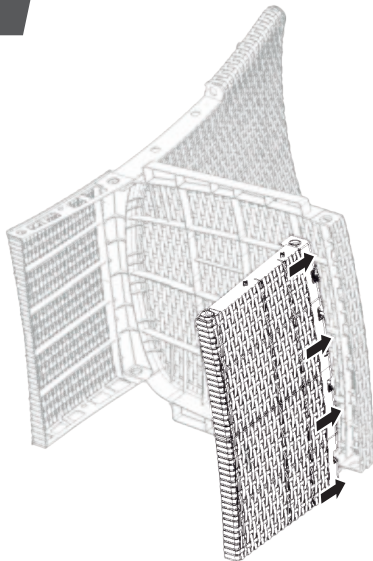
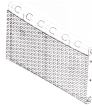

FB-LA x1

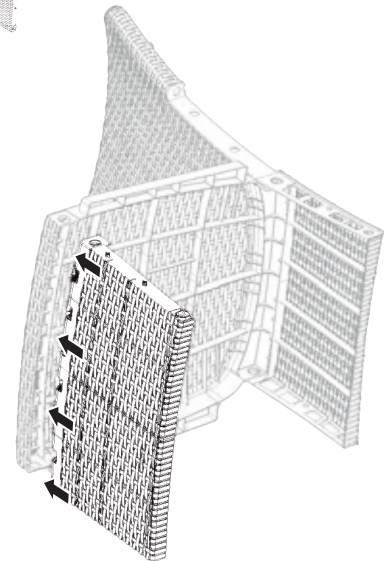

STEP
/ PASO

3



x1



x3



x2

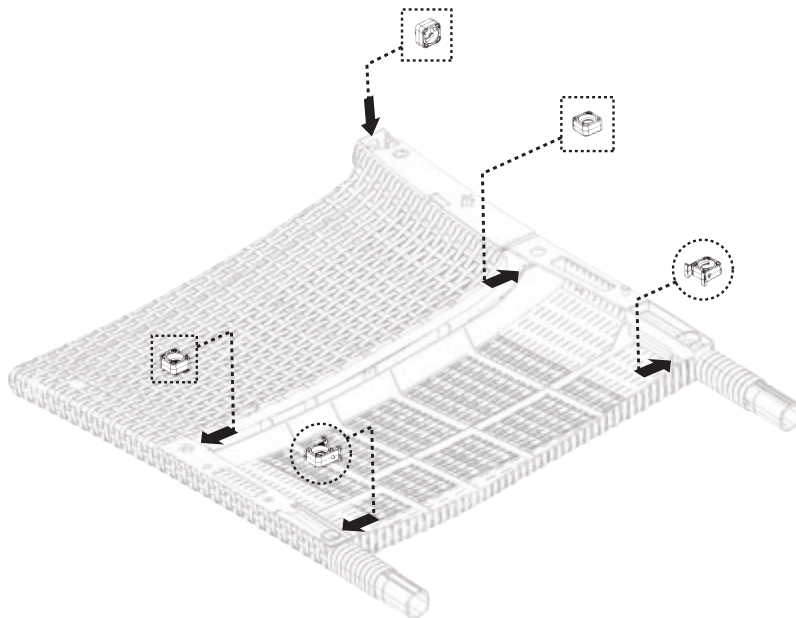

**REPEAT THIS STEP WITH THE
ANOTHER ARM OF THE CHAIR**
REPITE ESTE PASO CON EL
OTRO BRAZO DEL SILLÓN

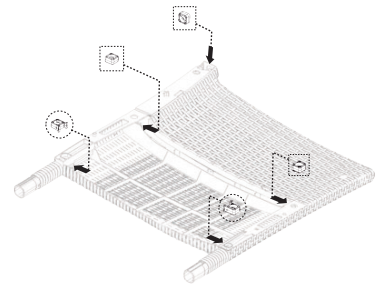

STEP / PASO **4**

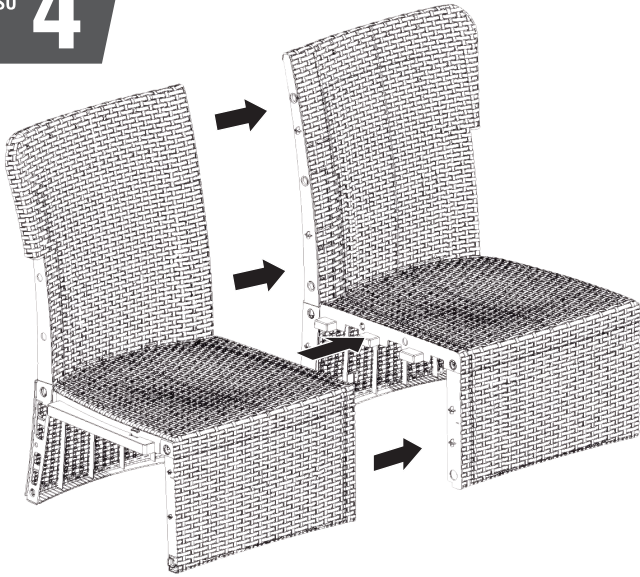

STEP / PASO **5**

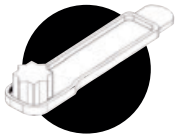

Use the included tool to secure the screws
 Utilice la herramienta incluida para asegurar los tornillos

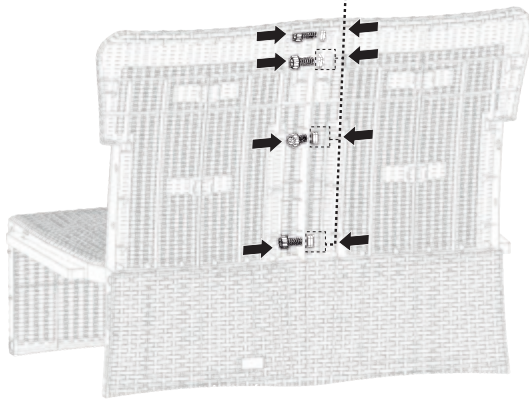

STEP / PASO **6**

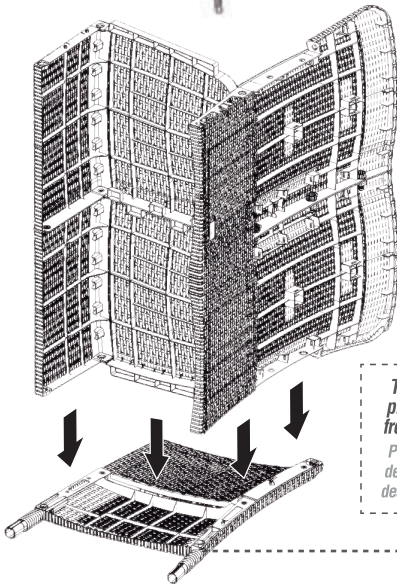

To do out this step, the (arm) piece must be pre-assembled from step 3
 Para realizar este paso la pieza (brazo) debe estar pre-ensamblada desde el paso 3



Use the included tool to secure the screws
 Utilice la herramienta incluida para asegurar los tornillos

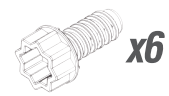

STEP / PASO **7**

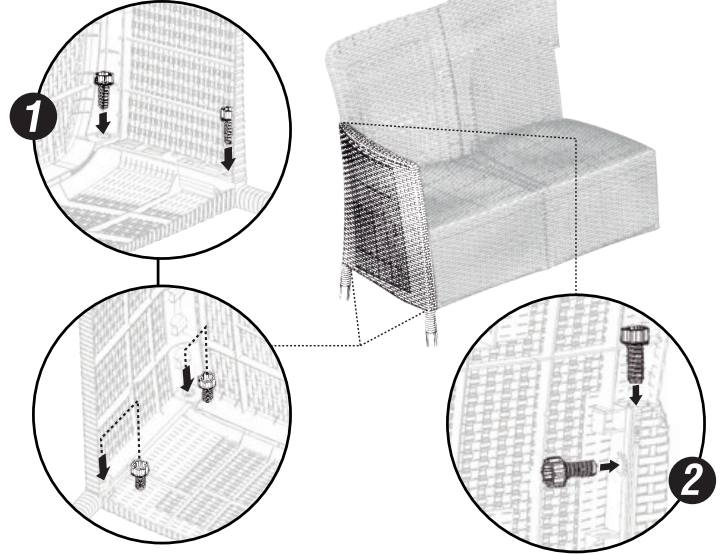

STEP / PASO **8**

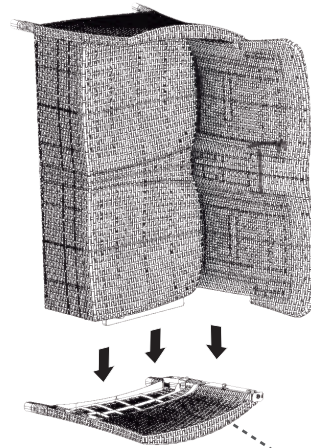

To do out this step, the (arm) piece must be pre-assembled from step 3
 Para realizar este paso la pieza (brazo) debe estar pre-ensamblada desde el paso 3



Use the included tool to secure the screws
 Utilice la herramienta incluida para asegurar los tornillos

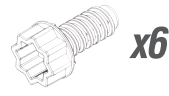

STEP / PASO **9**

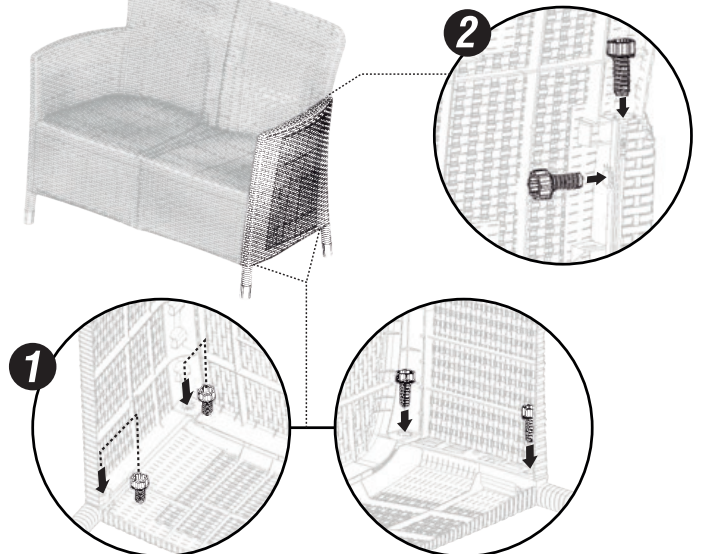

STEP / PASO

10

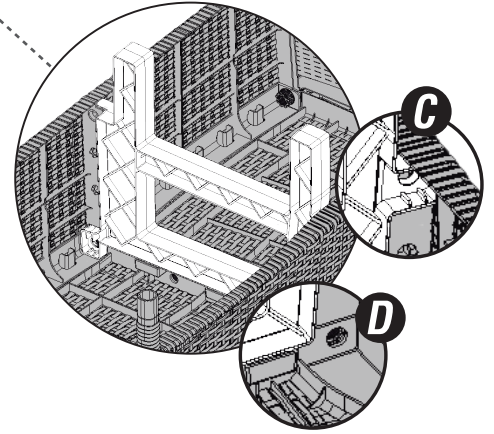
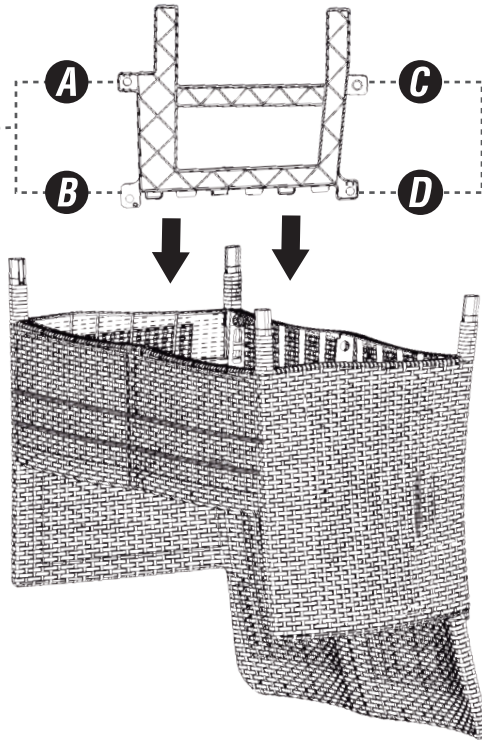
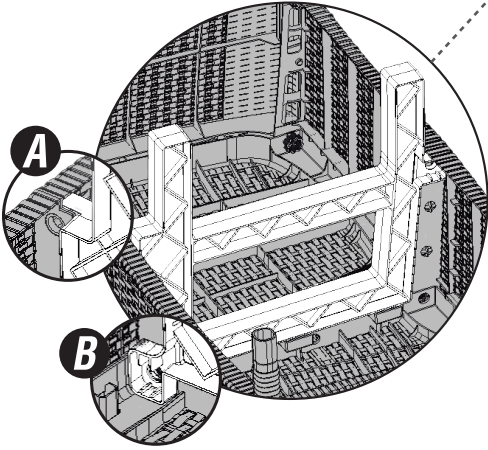

STEP / PASO

11



Front
Frente

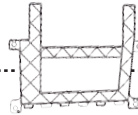

Back
Espalda

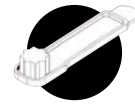
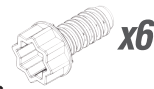

Use the included tool to secure the screws
Utilice la herramienta incluida para asegurar los tornillos

Opposite side
Lado contrario

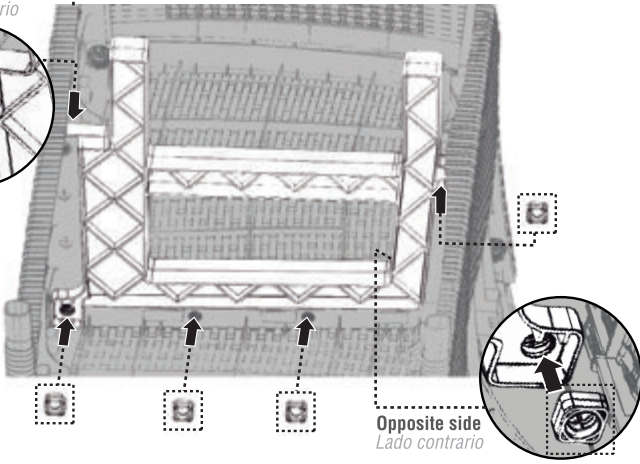
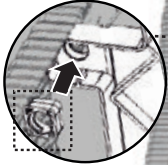

Opposite side
Lado contrario

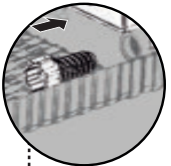

Opposite side
Lado contrario

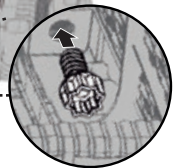

STEP / PASO

12



click

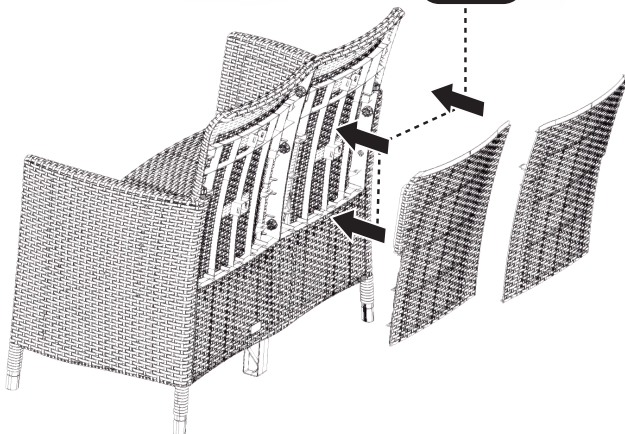

Check the identification number
Verifique el número de identificación

1-2-3-4



STEP / PASO

13

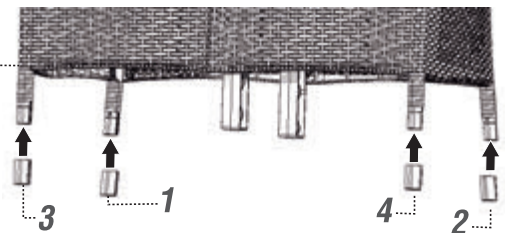
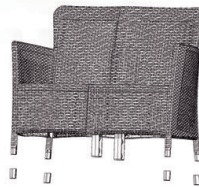



Video Version / Versión Video



·C|A|P|I|R|I·
MESA DE CENTRO / CENTER TABLE

ASSEMBLY INSTRUCTIONS
INSTRUCCIONES DE ENSAMBLE

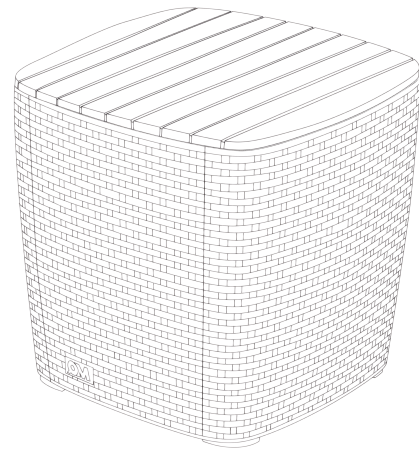

www.plasticosmq.com.co

/ Assembly Parts / Piezas de Ensamble

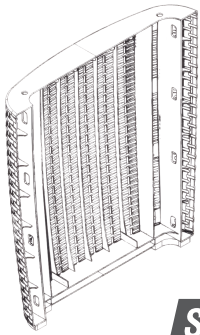

SA x2

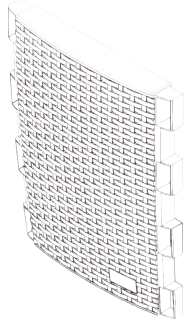

SB x2

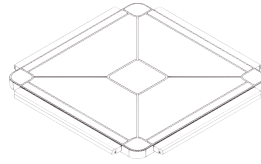

FL x1

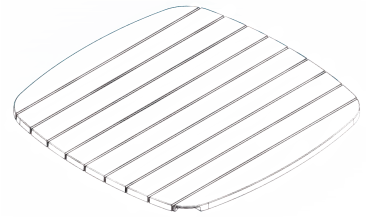

CA x1

STEP / PASO **1**

SA x2

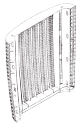

SB x2

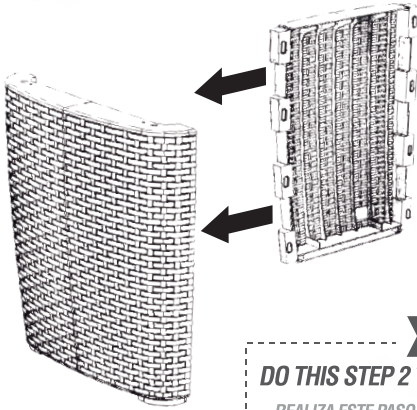

x2
DO THIS STEP 2 TIMES
REALIZA ESTE PASO 2 VECES

STEP / PASO **3**

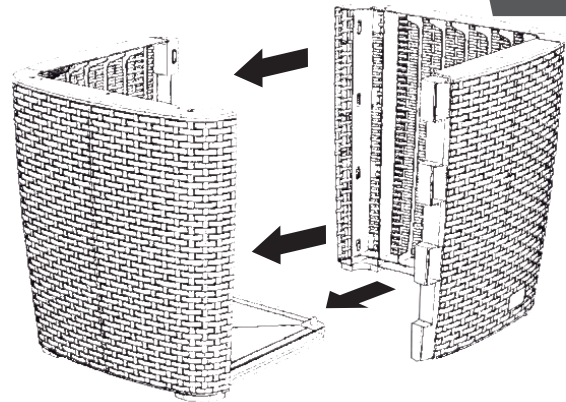

STEP / PASO **2**

FL x1

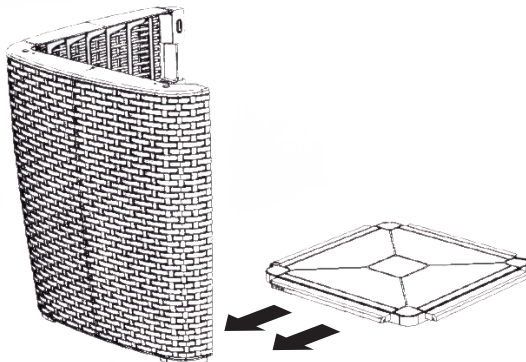

STEP / PASO **4**

CA x1

