



FERRARA PATIO SET

SALA FERRARA ESTAR

ASSEMBLY INSTRUCTIONS
INSTRUCCIONES DE ENSAMBLE



/ Assembly Parts / Piezas de Ensamble

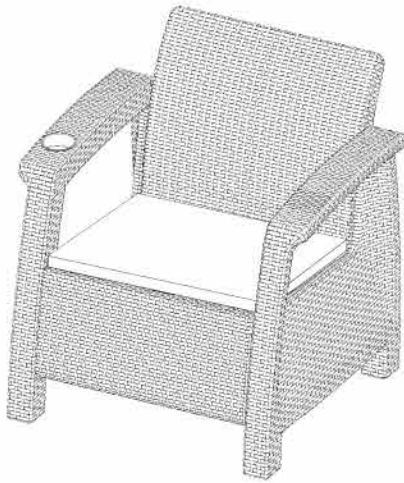

Video Version / Versión Video

FERRARA CHAIR

SILLÓN FERRARA

/ 2 Cushions included / Incluidos 2 cojines

Required Tool / Herramienta Requerida
*Included / Incluida

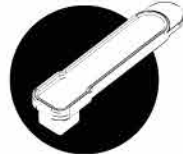

X2

Screw Wrench
/ Llave para tornillos

X1

Includes 1 replacement screw
Incluye 1 tornillo de repuesto

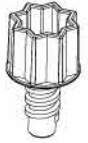

X1

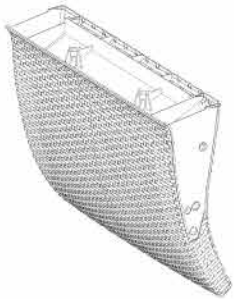

BX2



RAX2



LAX2

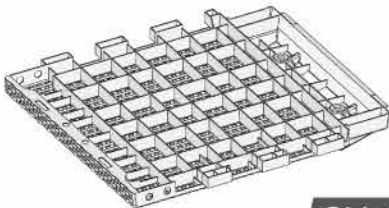

SX2

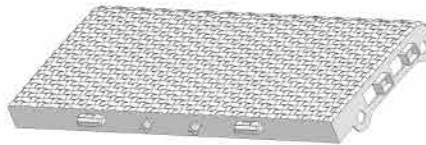

FBX4



X32



X8

STEP / PASO

1



Bx1



Sx1

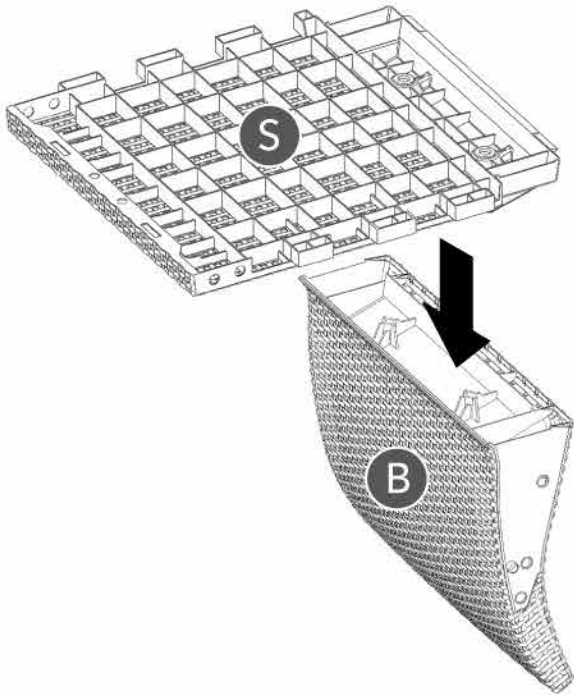

STEP / PASO

3



FBx1

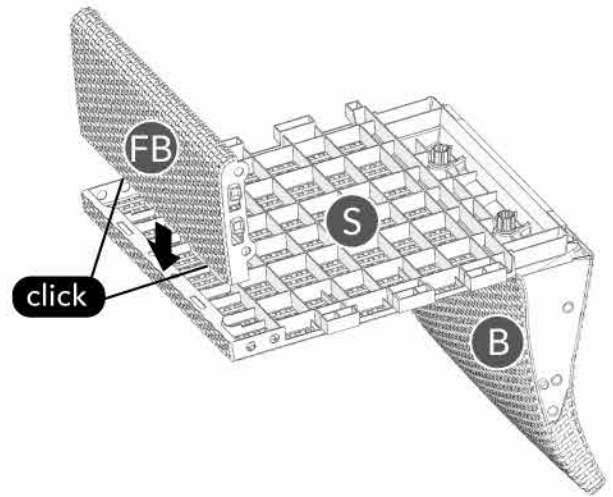

STEP / PASO

2



x2

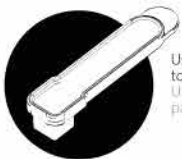

Use the included tool to secure the screws.
Utilice la herramienta incluida para asegurar los tornillos

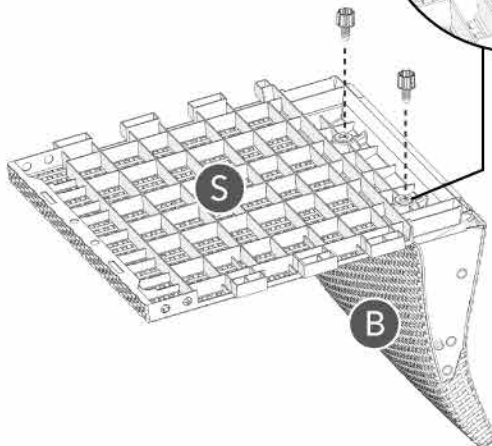
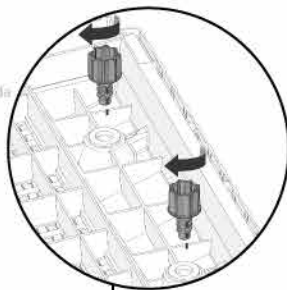

STEP / PASO

4



RAx1

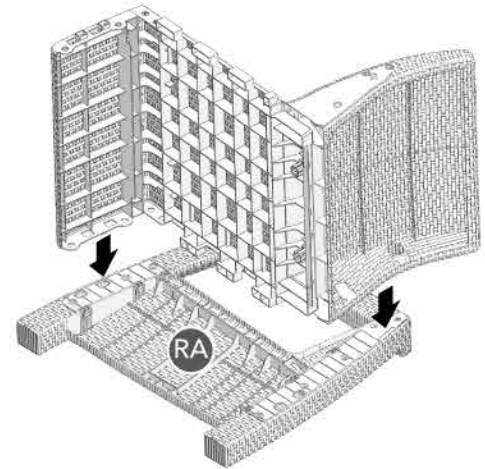

STEP / PASO

5



FBx1

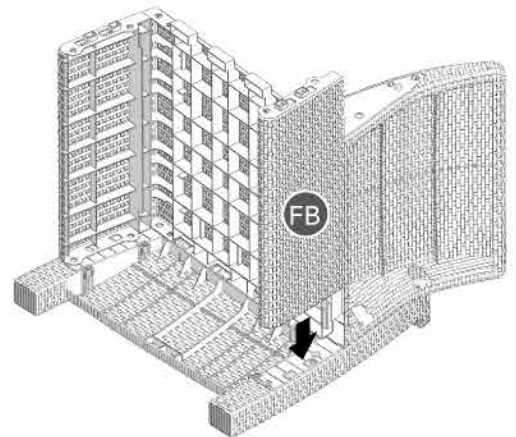

STEP
/ PASO

6



Use the included tool
to secure the screws
Utilice la herramienta incluida
para asegurar los tornillos

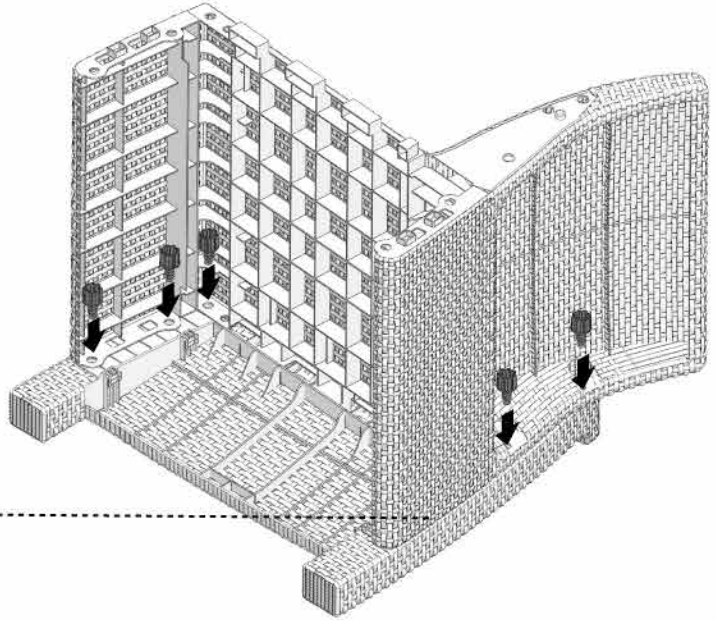
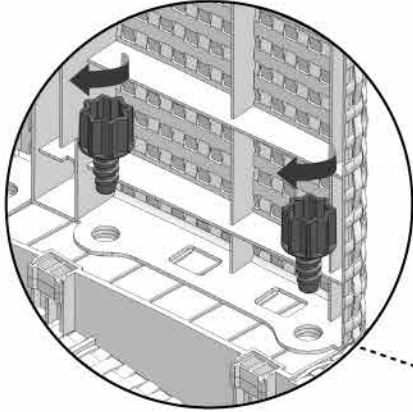

STEP
/ PASO

7



LAX1

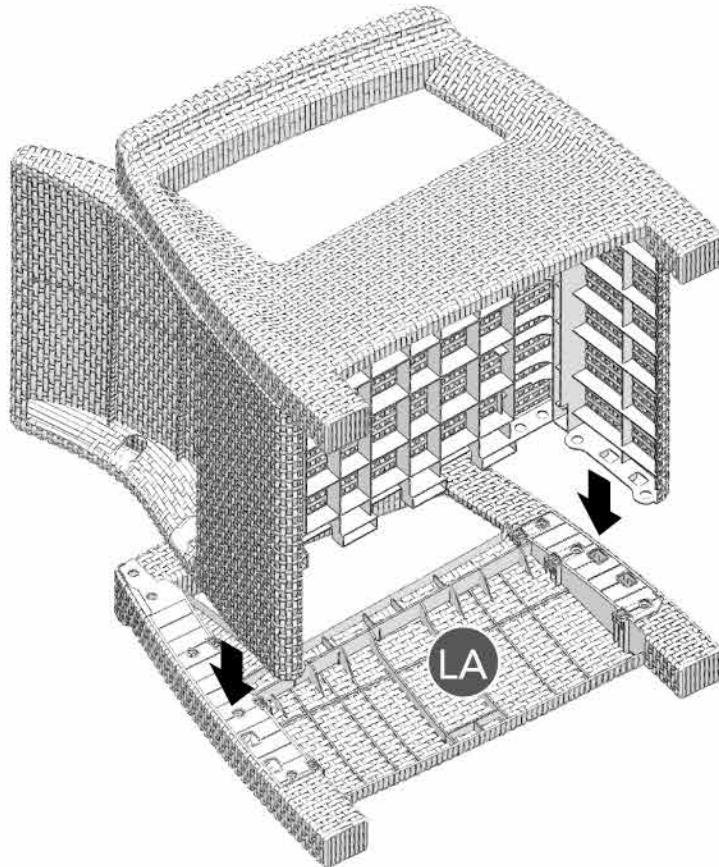

STEP / PASO 8

 x7

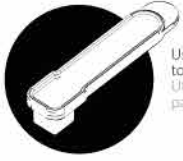

Use the included tool to secure the screws
Utilice la herramienta incluida para asegurar los tornillos

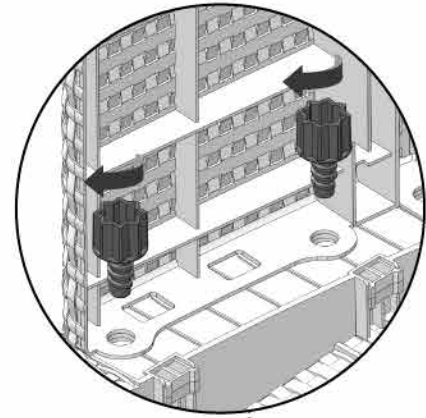
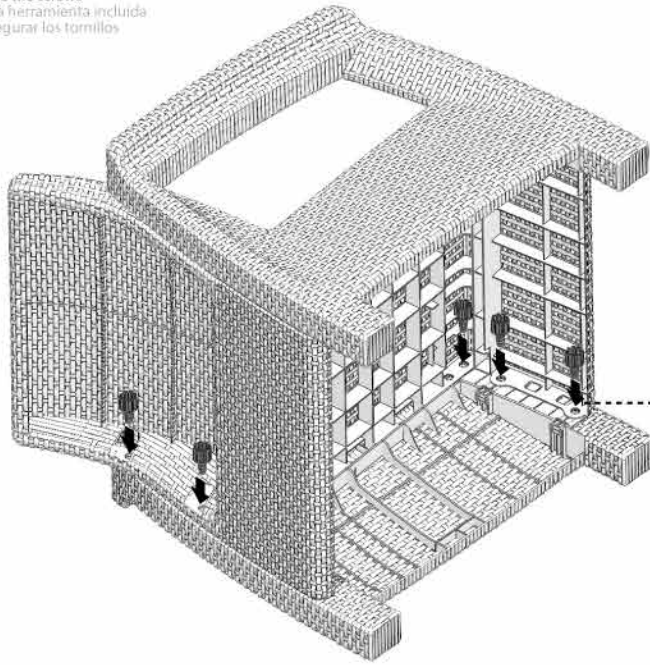

STEP / PASO 9

 1x1  2x1  3x1  4x1

click

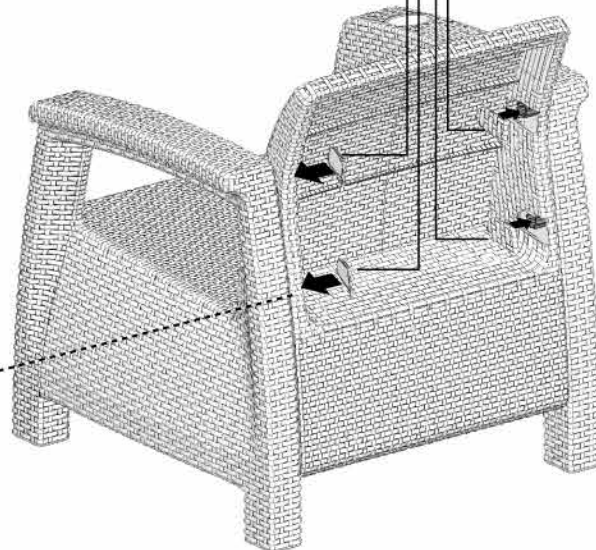
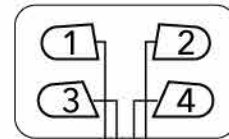
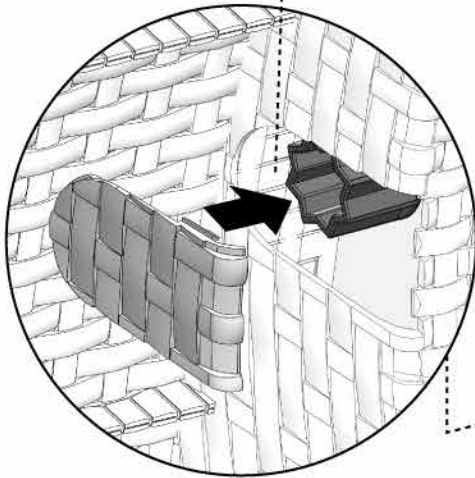

NEW NUEVO
ACCESSORY ACCESORIO

2 OPTIONS
OPCIONES

COVER
TAPA

GLASS HOLDER
PORTAVASOS

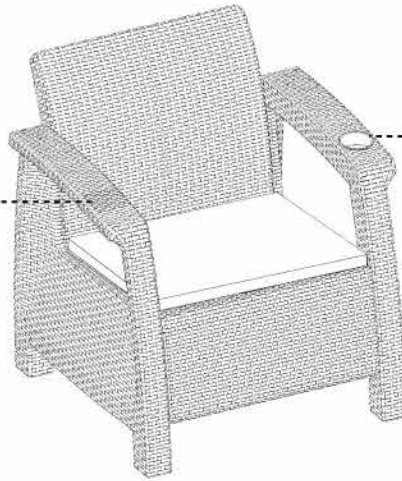

EASY ASSEMBLY
FÁCIL ENSAMBLE

COVER
TAPA

GLASS HOLDER
PORTAVASOS





Video Version / Versión Video



·C|A|P|R|I·

MESA DE CENTRO / CENTER TABLE

ASSEMBLY INSTRUCTIONS

INSTRUCCIONES DE ENSAMBLE

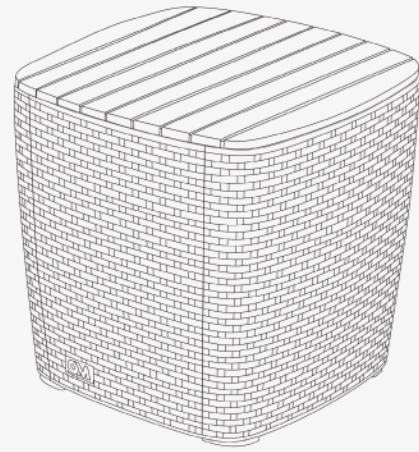

x1

www.plasticosmq.com.co

/ Assembly Parts / Piezas de Ensamble

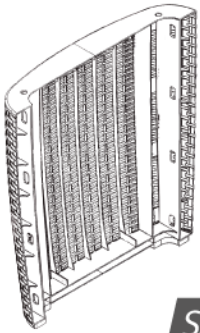

SA x2

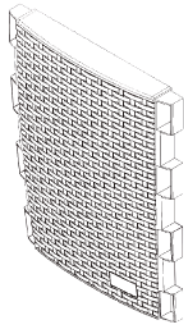

SB x2

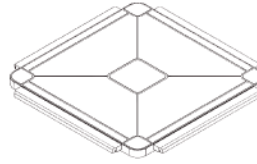

FL x1

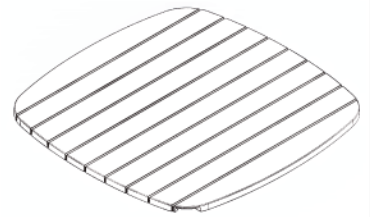

CA x1

STEP / PASO 1

SA x2



SB x2

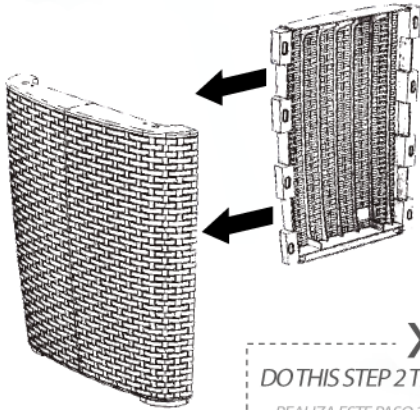

x2
DO THIS STEP 2 TIMES
REALIZA ESTE PASO 2 VECES

STEP / PASO 3

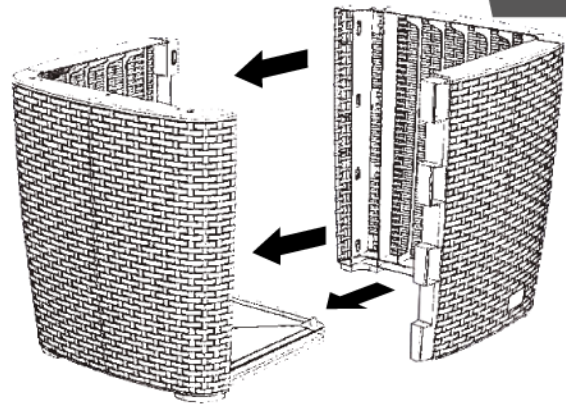

STEP / PASO 2

FL x1

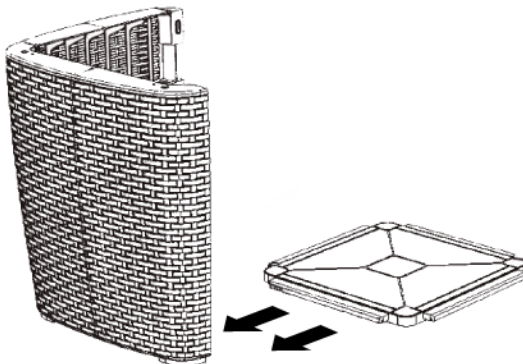

STEP / PASO 4

CA x1

