

MQ[®]

FERRARA LUXURY SET SALA FERRARA LUXURY

ASSEMBLY INSTRUCTIONS
INSTRUCCIONES DE ENSAMBLE

VZ

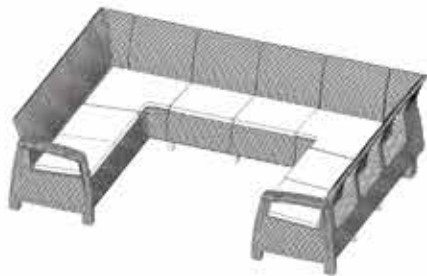
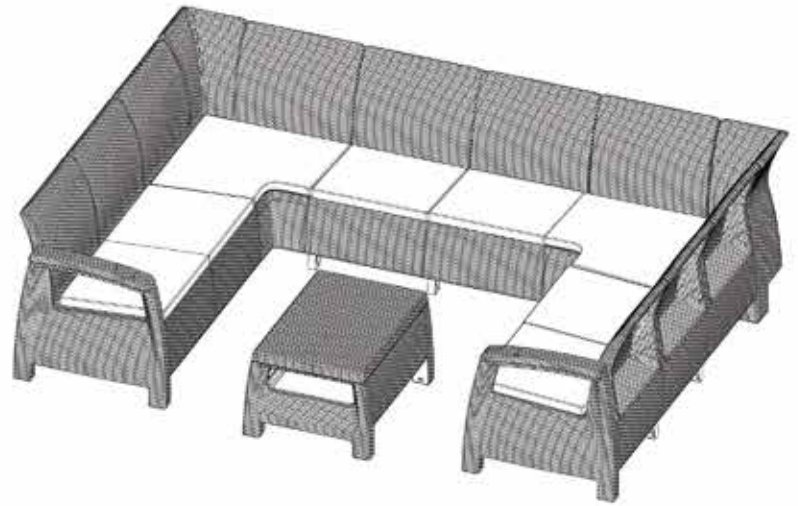

E1	S2	E2
S1		S3

FERRARA C-SHAPED SOFA SOFÁ FERRARA EN C

| 8 Cushions included | Incluidos 8 cojines

/ Assembly Parts / Piezas de Ensamble



Bx10



RAx1



LAx1

Required Tool / Herramienta Requerida
*Included / *Incluida



Screw Wrench
/ Llave para tornillos

x2

Includes 4 additional screws
Incluye 4 tornillos adicionales



x99



x4



Sx6

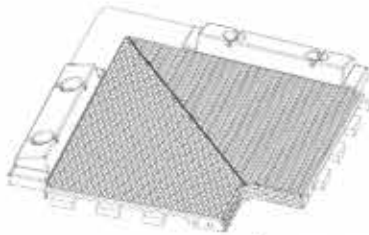

STCx2

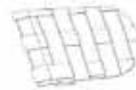

x40



A x4



B x4



C x4



D x4



SSx7



CSx7

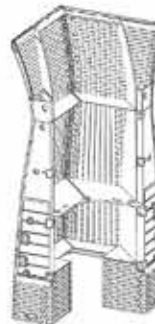

TOCx2



BKCx2



FTCx2



FBx16

E1			

E1 SECTION / SECCIÓN E1

STEP / PASO

1

Check the marked letter
Verifique la letra marcada

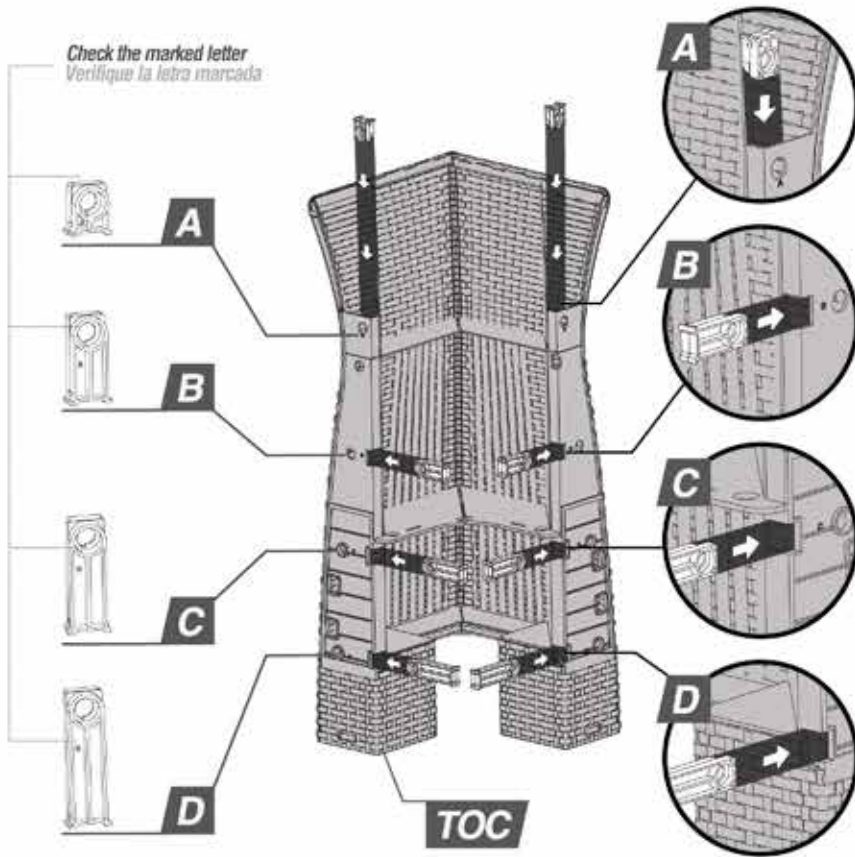

STEP / PASO

2

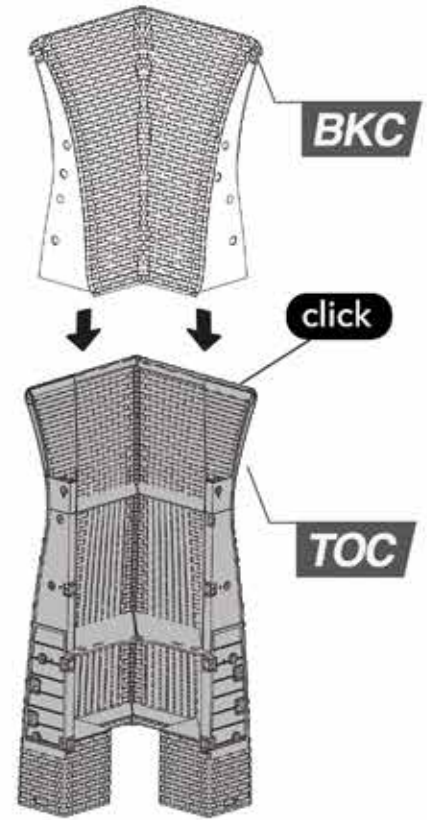

STEP / PASO

3

TOC

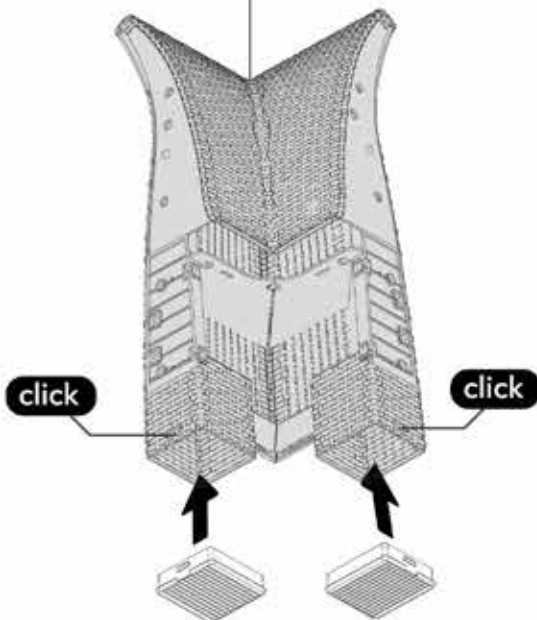

STEP / PASO

4

B

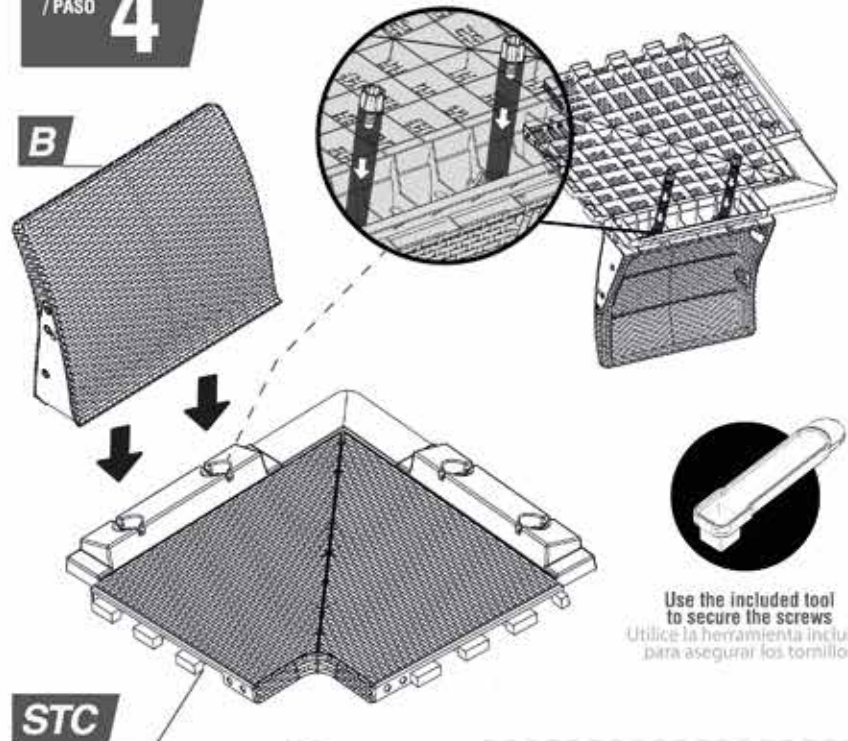

Use the included tool
to secure the screws
Utilice la herramienta incluida
para asegurar los tornillos



FERRARA C-SHAPED SOFA
SOFA FERRARA EN C

STEP / PASO **5**

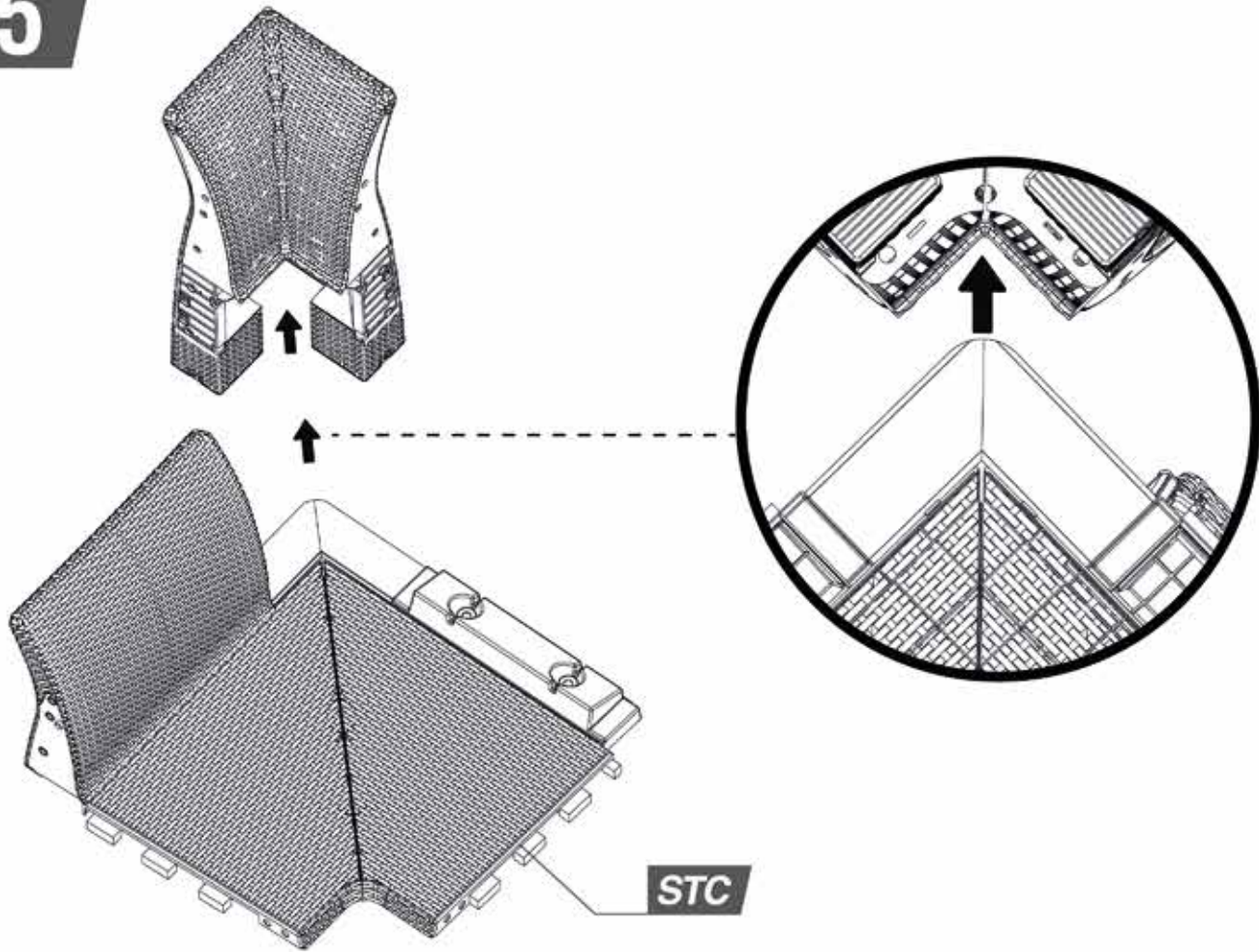

STEP / PASO **6**

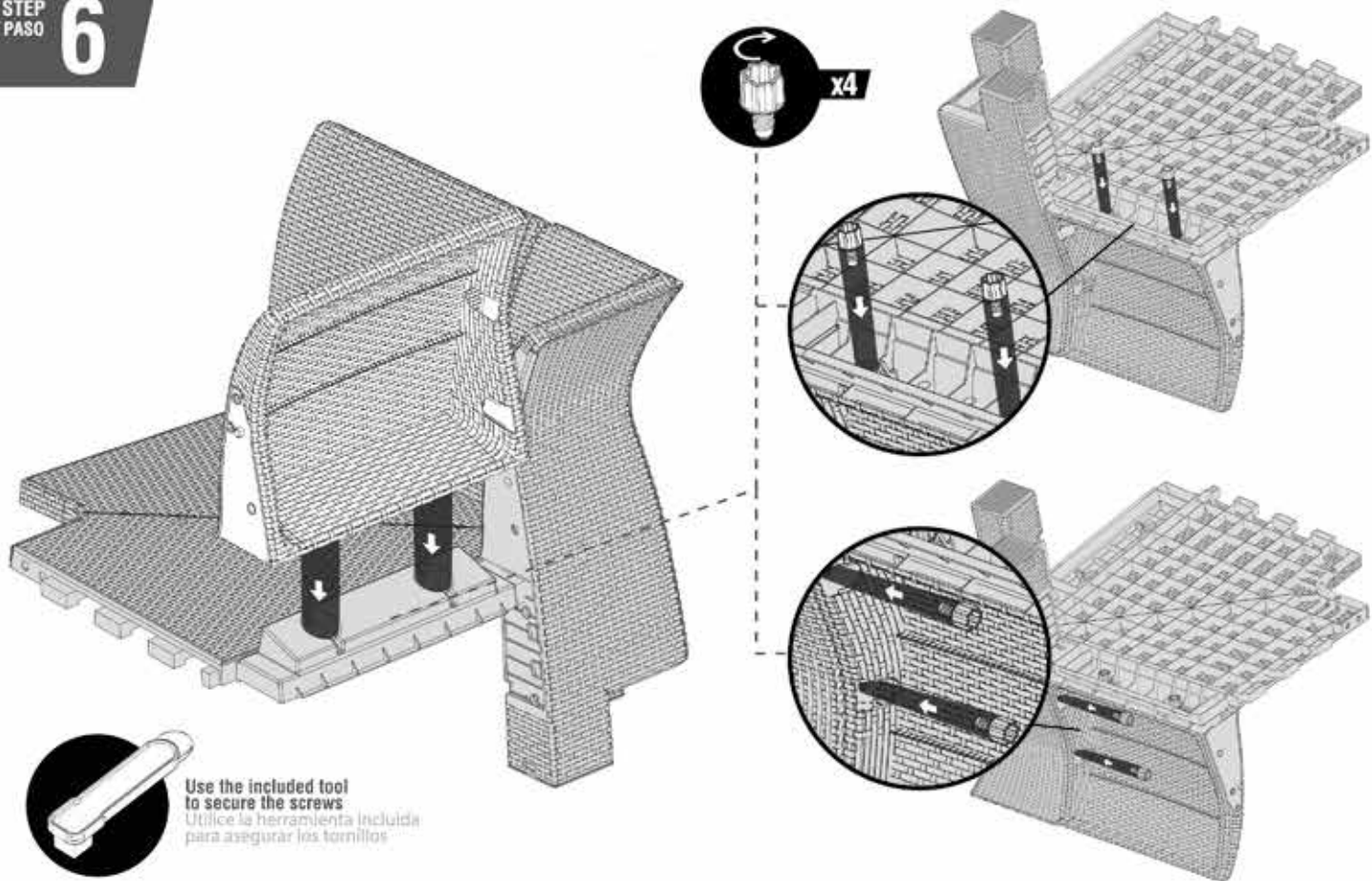

STEP / PASO **7**

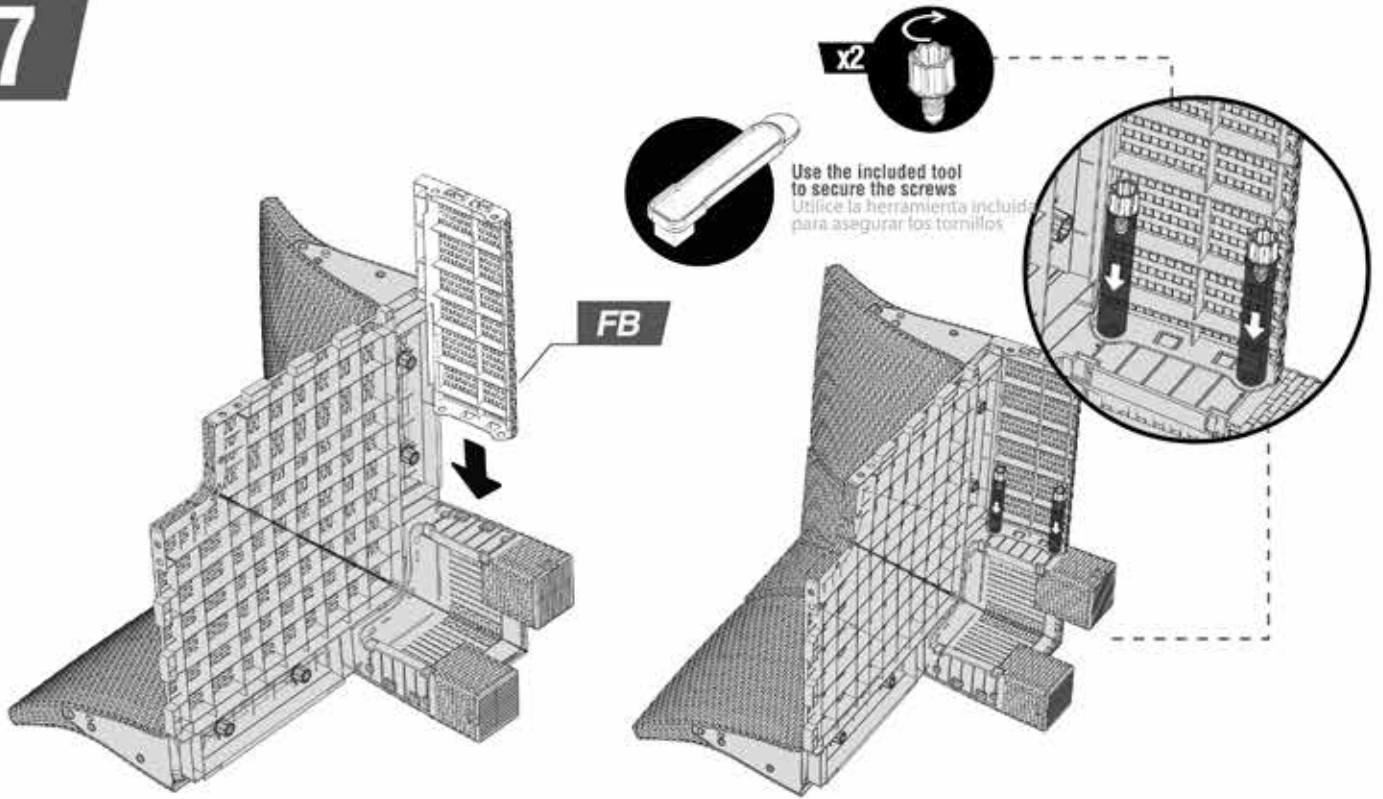

STEP / PASO **8**

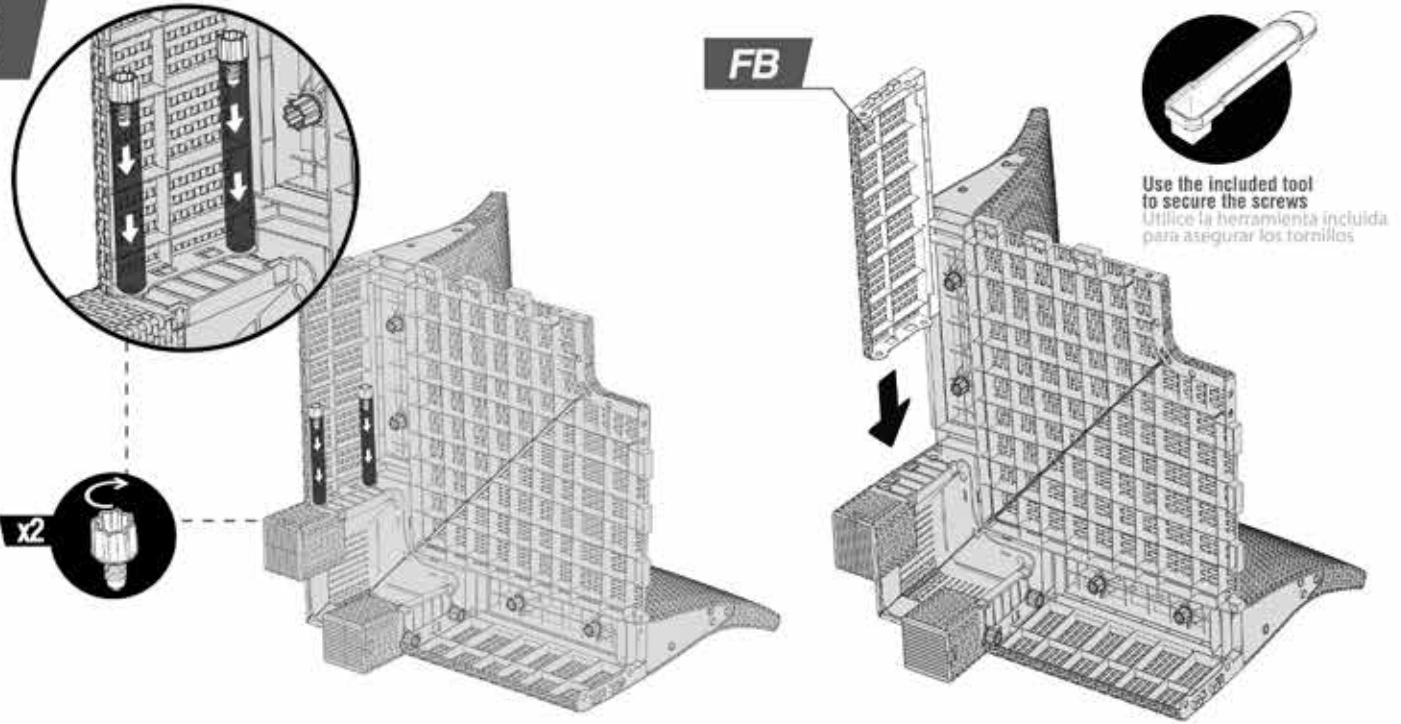

STEP / PASO **9**

E2 SECTION / SECCIÓN E2

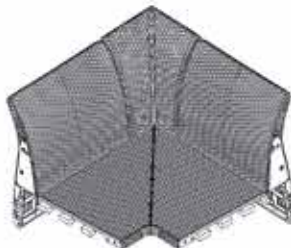
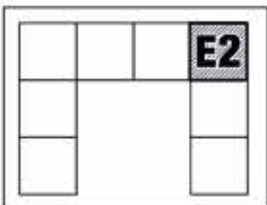

Repeat steps 1 through 8 to assemble E2 section
 Repita los pasos 1 al 8 para ensamblar la sección E2

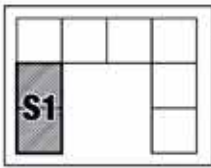

S1 SECTION / SECCIÓN S1

STEP / PASO

10

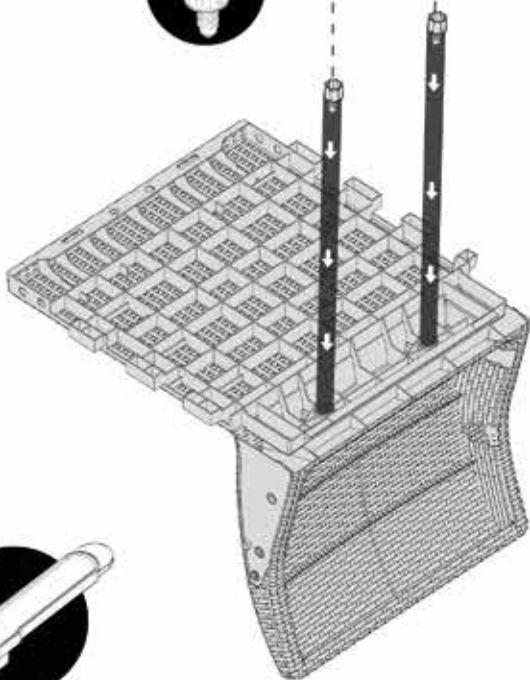
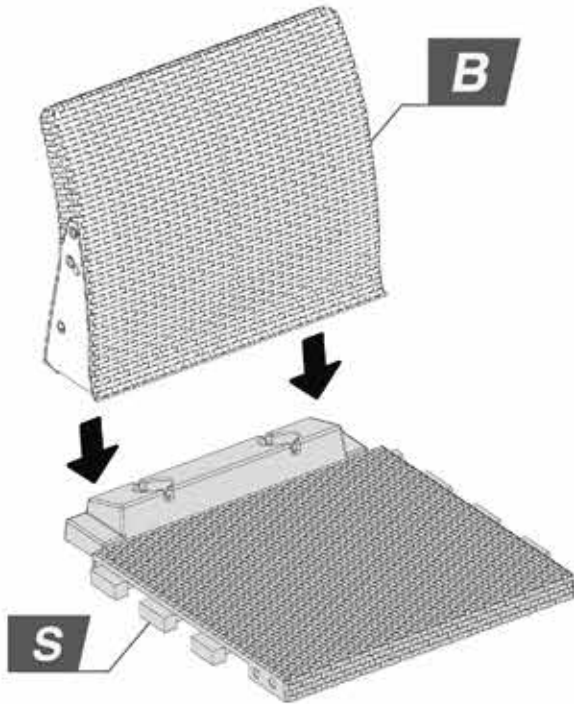

Use the included tool to secure the screws
Utilice la herramienta incluida para asegurar los tornillos

x6

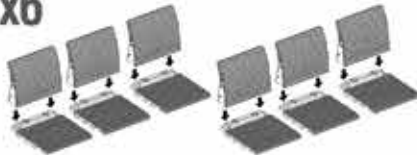

DO THIS STEP 6 TIMES
REALIZA ESTE PASO 6 VECES

STEP / PASO

11

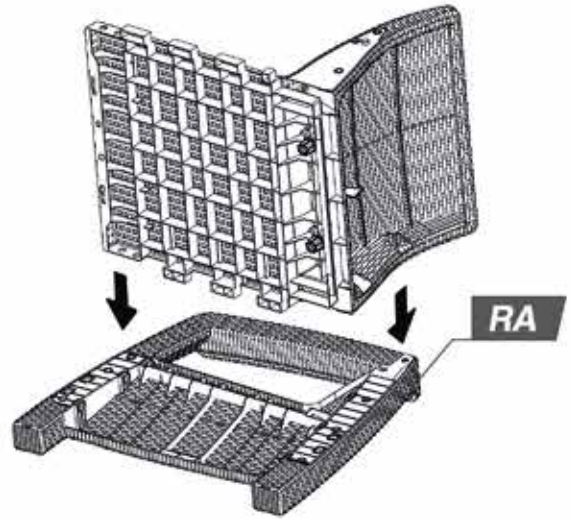

STEP / PASO

12

click

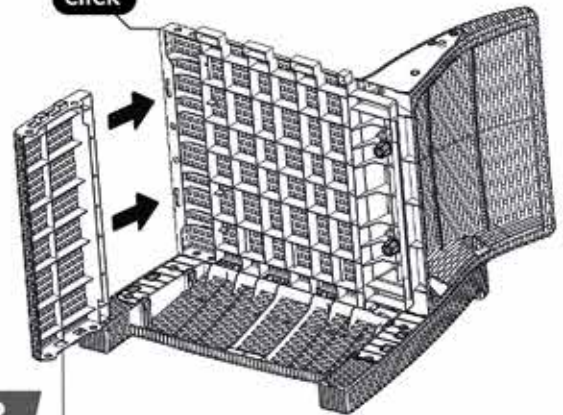

FB

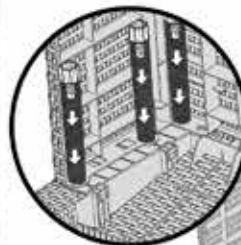

Use the included tool to secure the screws
Utilice la herramienta incluida para asegurar los tornillos

x5



STEP / PASO **13**

FB

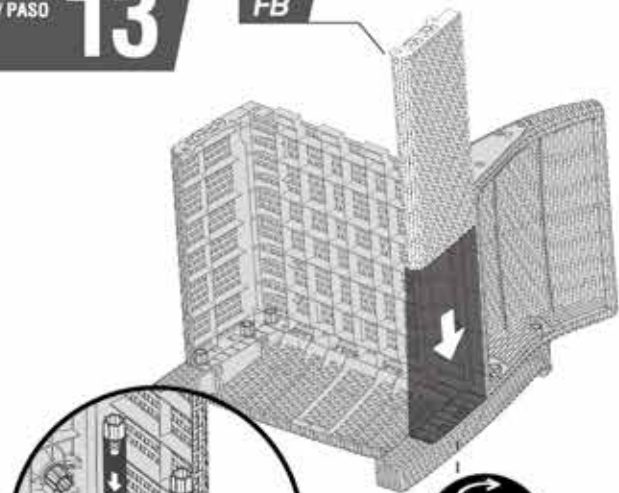

Use the included tool to secure the screws
Utilice la herramienta incluida para asegurar los tornillos

STEP / PASO **16**

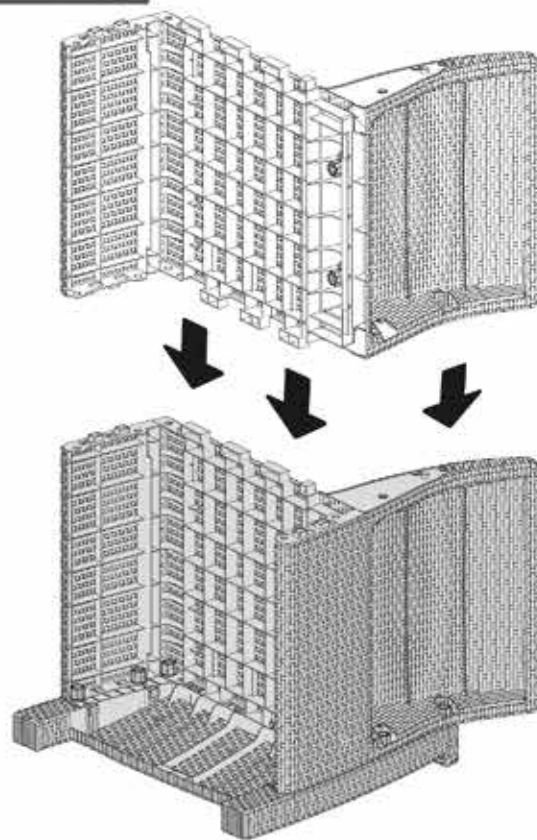

STEP / PASO **14**

CS

SS

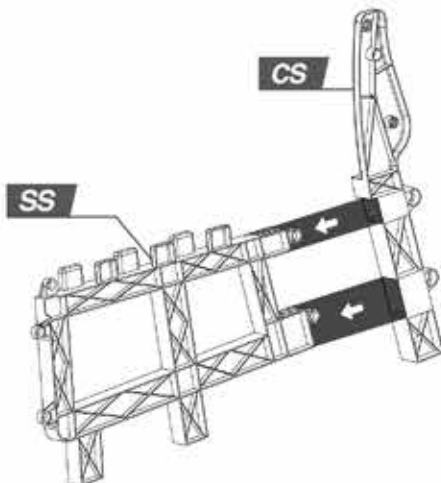

x7

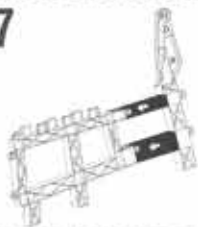

DO THIS STEP 7 TIMES
REALIZA ESTE PASO 7 VECES

STEP / PASO **15**

click

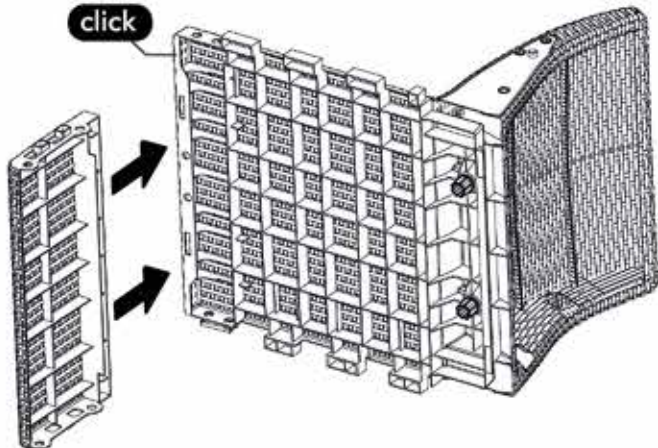

STEP / PASO **17**

FB

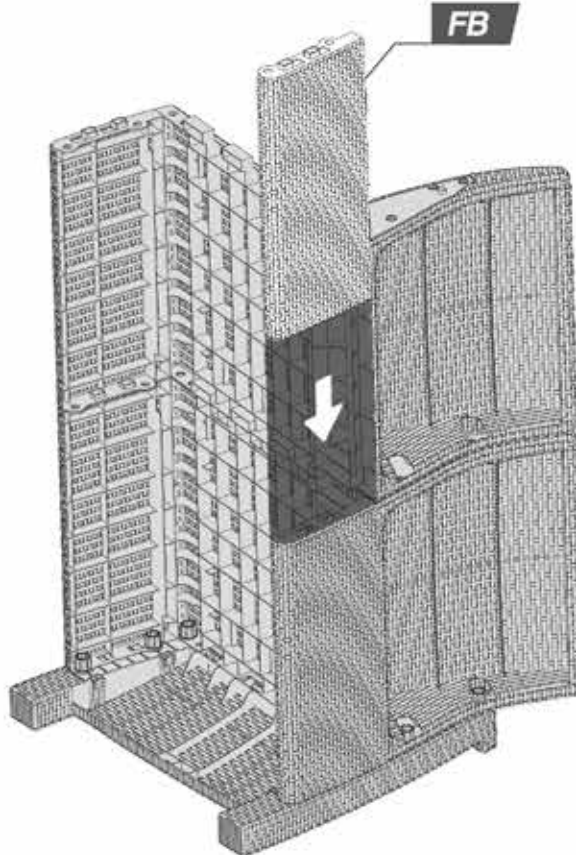

STEP / PASO

18

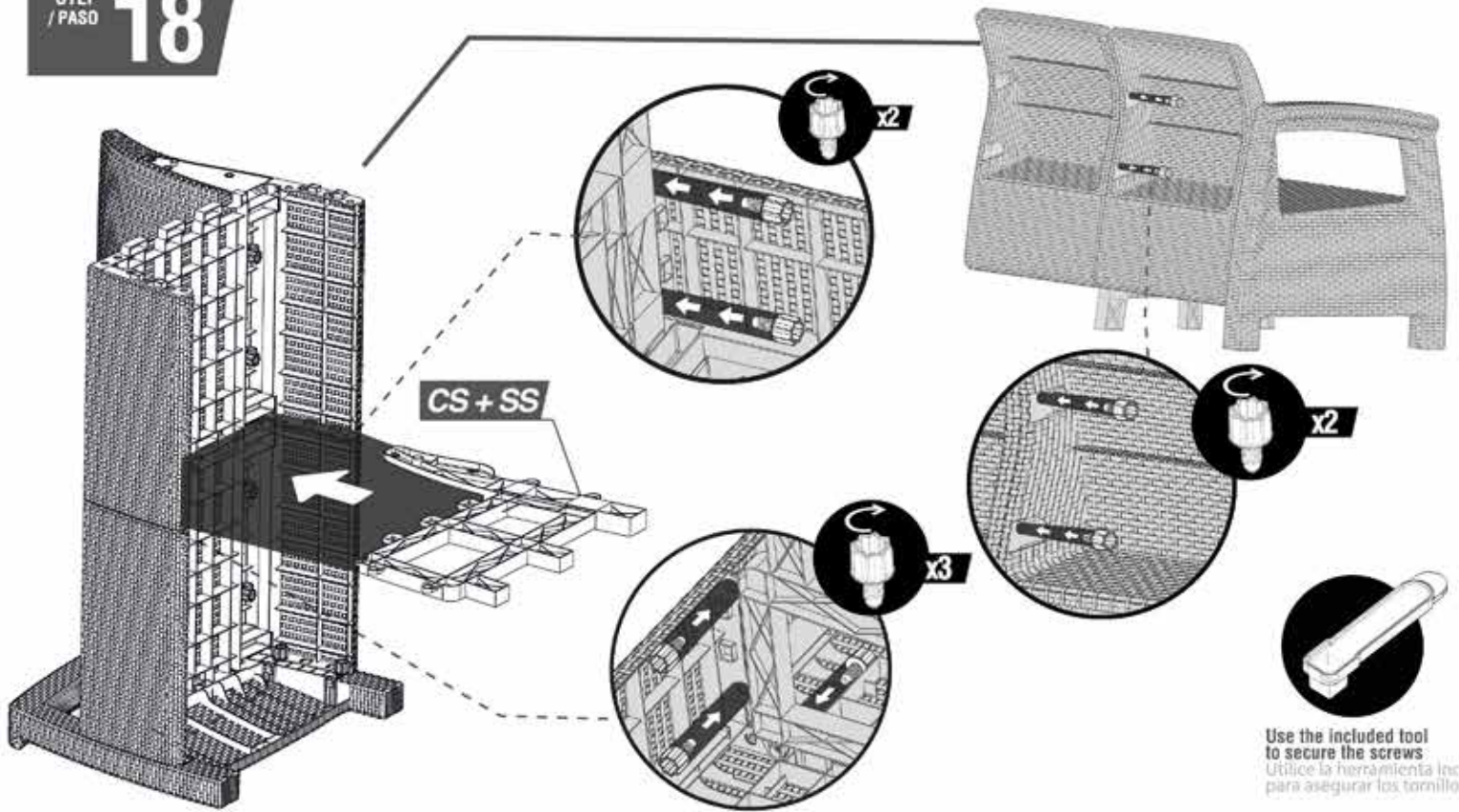

Use the included tool to secure the screws
 Utilice la herramienta incluida para asegurar los tornillos

STEP / PASO

19

S3 SECTION / SECCIÓN S3

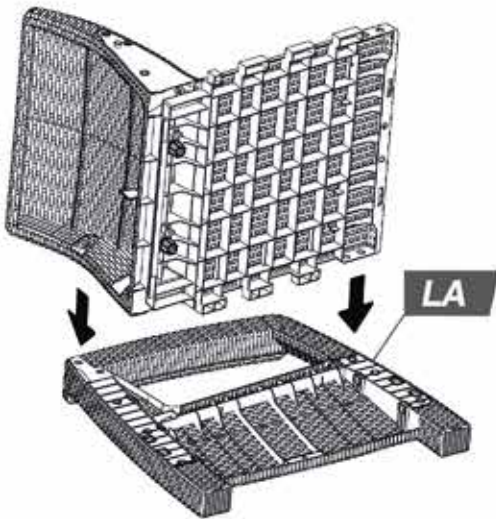
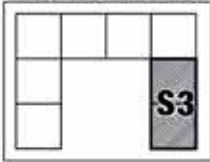

Use the included tool to secure the screws
 Utilice la herramienta incluida para asegurar los tornillos

STEP / PASO

20

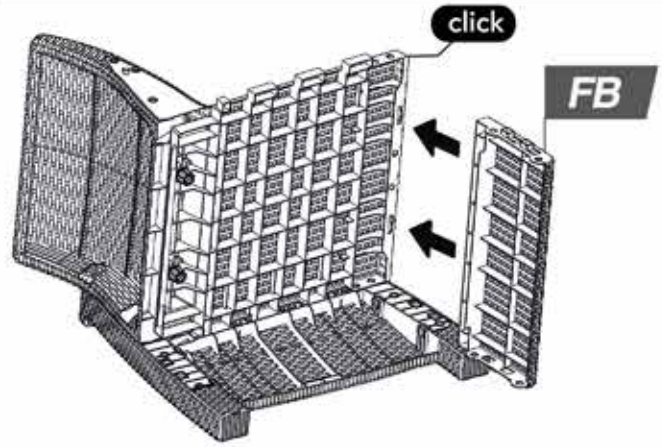

STEP / PASO

21

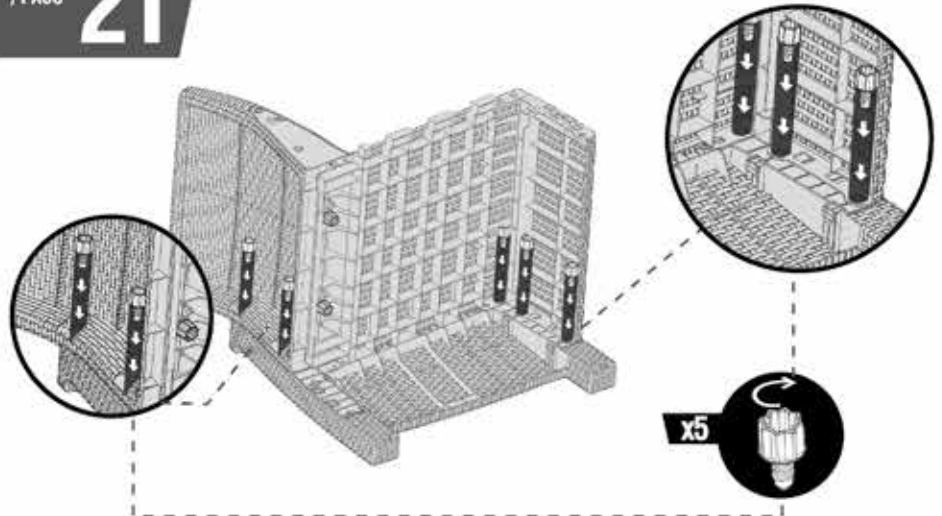

STEP / PASO **22**

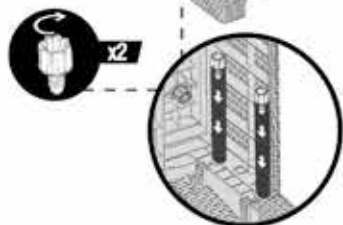
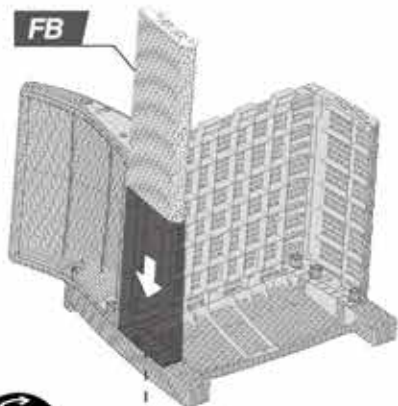

Use the included tool to secure the screws
Utilice la herramienta incluida para asegurar los tornillos

STEP / PASO **23**

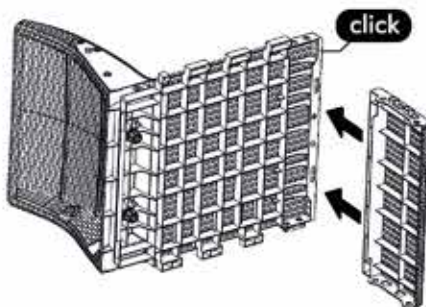

STEP / PASO **24**

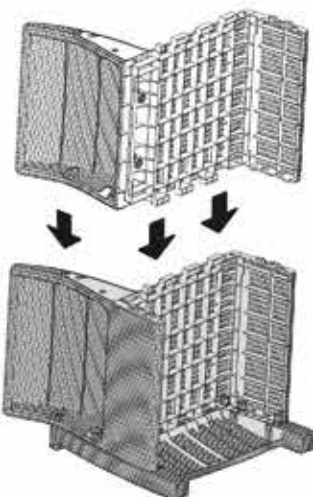

STEP / PASO **25**

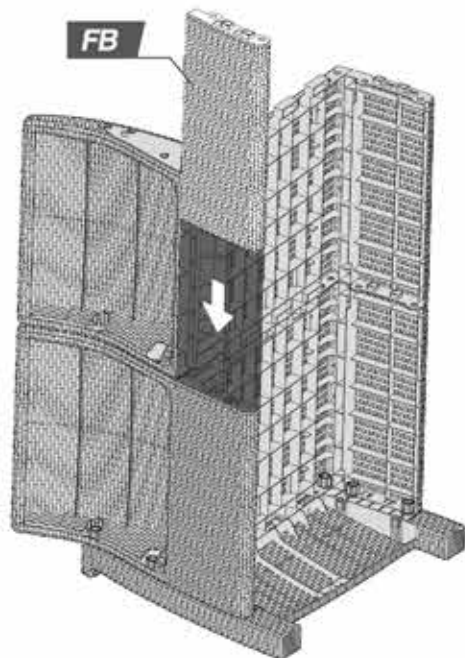

STEP / PASO **26**

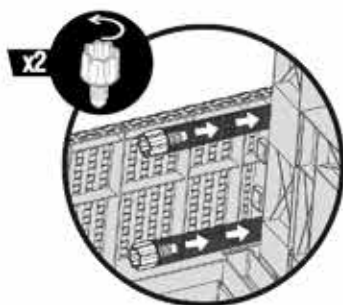

CS + SS

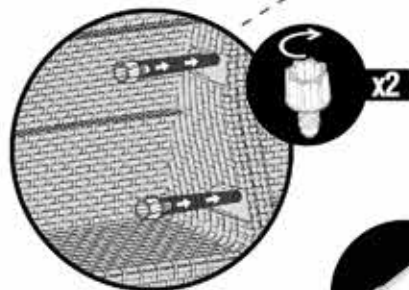
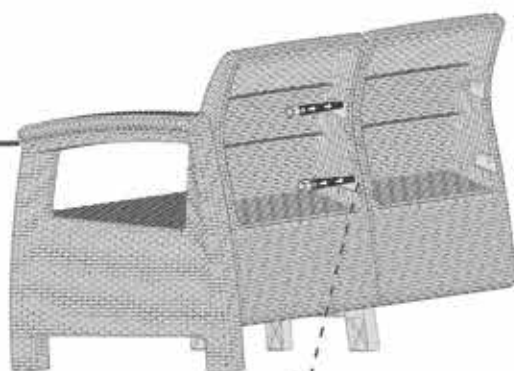
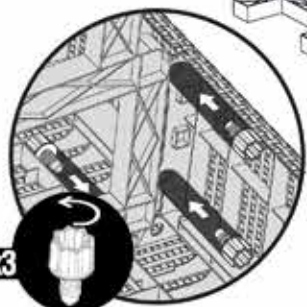

Use the included tool to secure the screws
Utilice la herramienta incluida para asegurar los tornillos

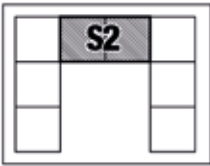

S2 SECTION / SECCIÓN S2

STEP / PASO **27**

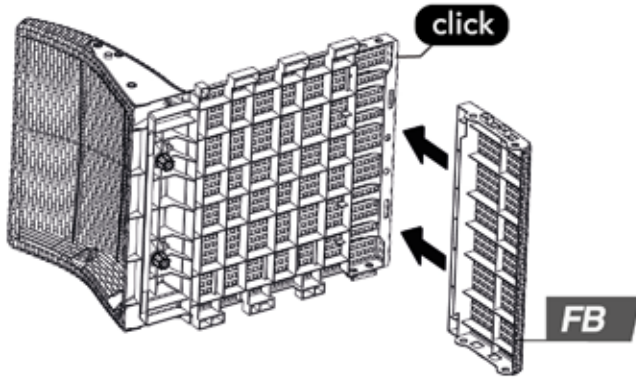

DO THIS STEP 2 TIMES
REALIZA ESTE PASO 2 VECES

STEP / PASO **28**

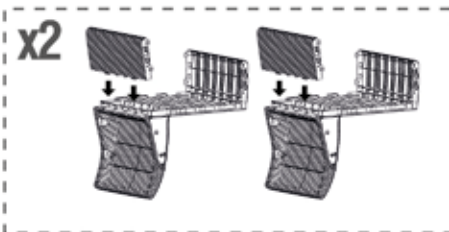
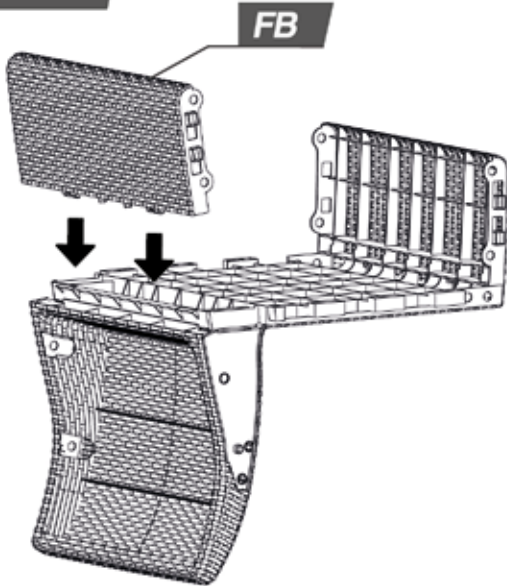

DO THIS STEP 2 TIMES
REALIZA ESTE PASO 2 VECES

STEP / PASO **29**

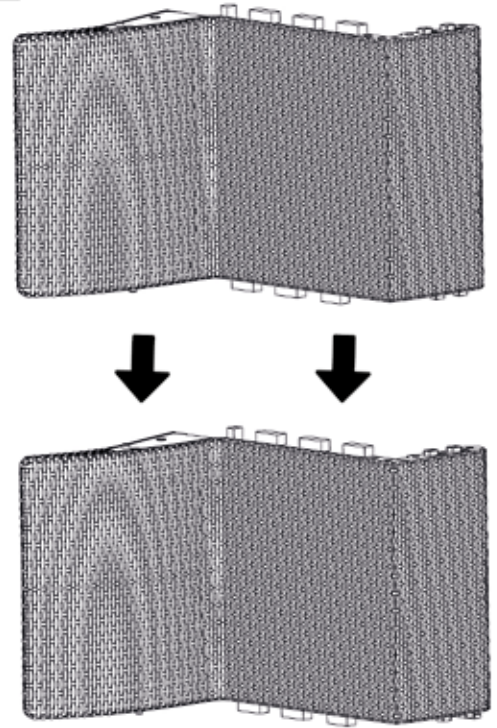

STEP / PASO **30**

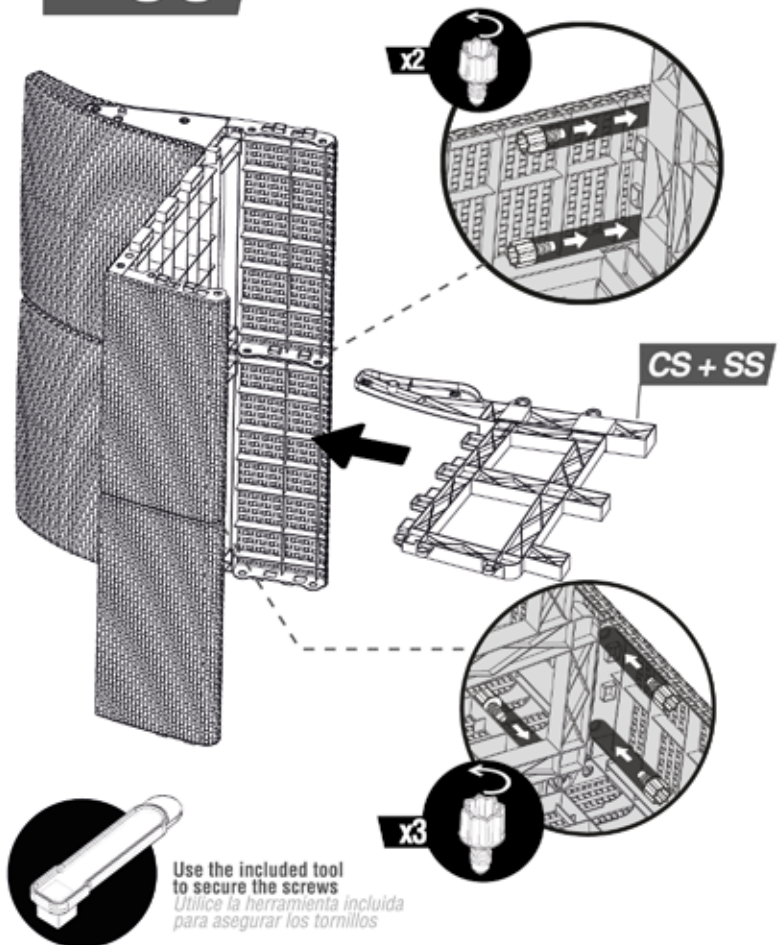

Use the included tool
to secure the screws
Utilice la herramienta incluida
para asegurar los tornillos

STEP / PASO **31**

S2 SECTION / SECCIÓN S2

E1	S2	

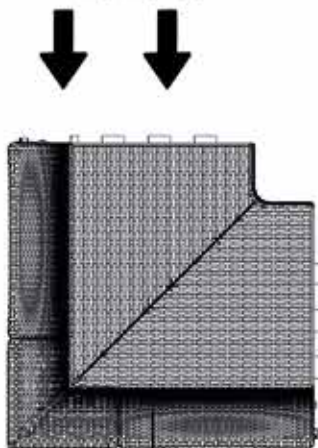

E1

STEP / PASO **32**

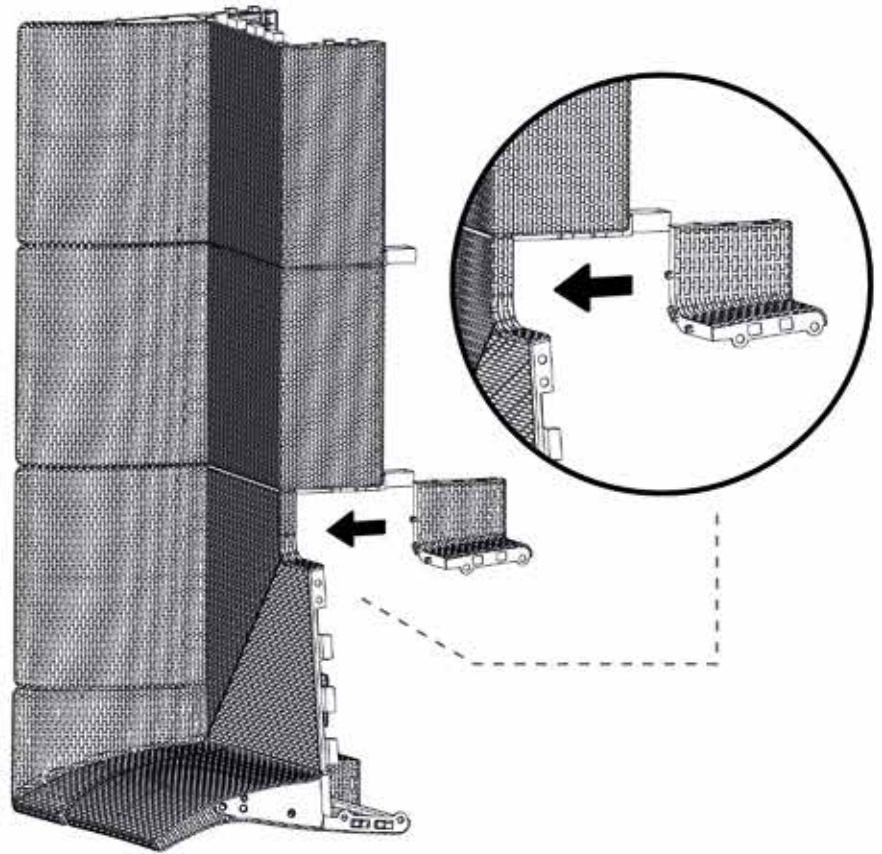

STEP / PASO **33**

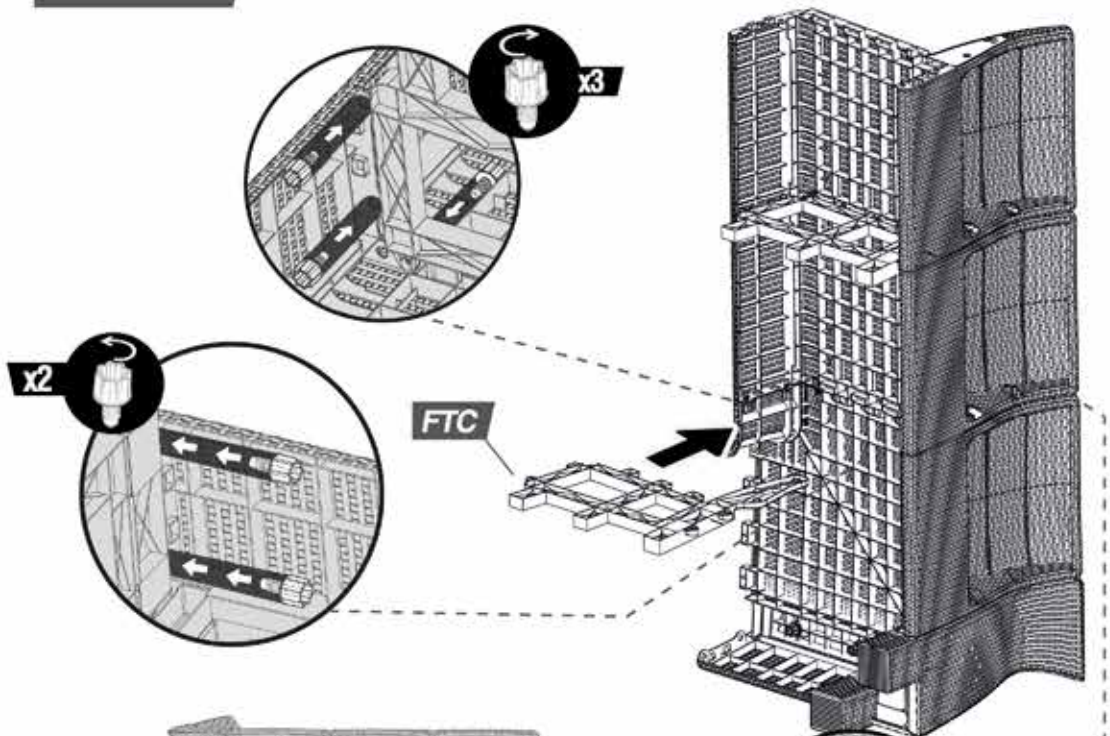

Use the included tool to secure the screws
Utilice la herramienta incluida para asegurar los tornillos.

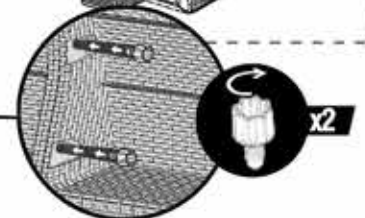

STEP / PASO

34

E1, S2 + E2 SECTION / SECCIONES E1, S2 + E2

E1	S2	E2

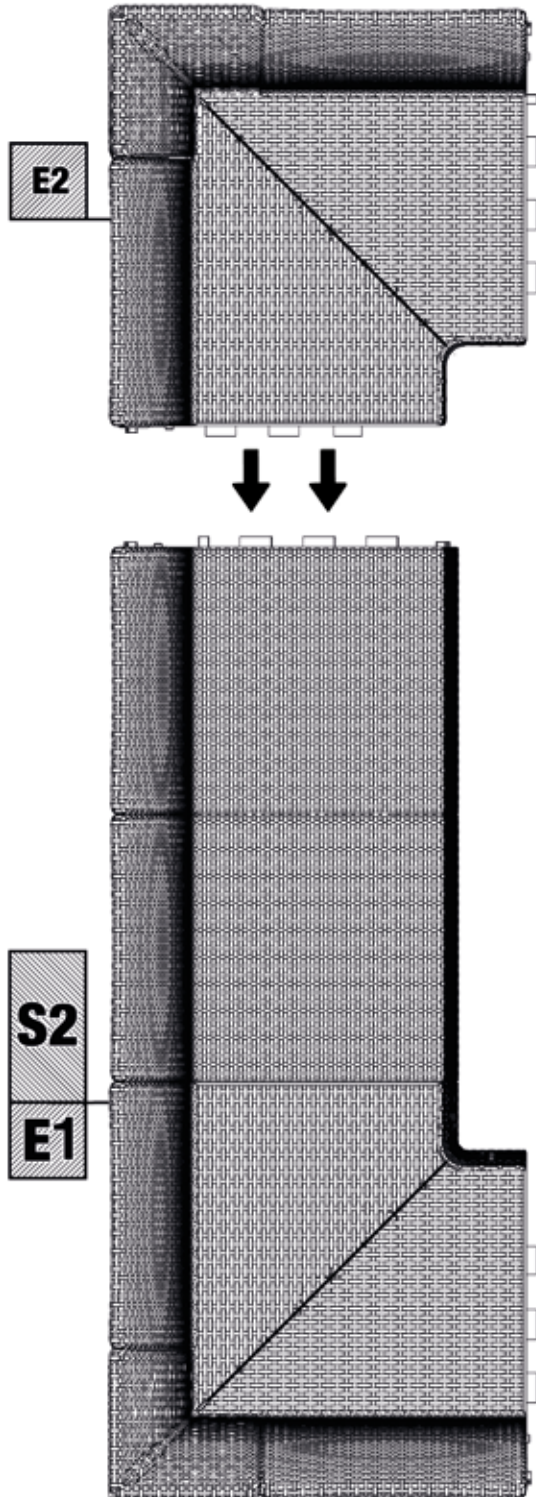

STEP / PASO

35

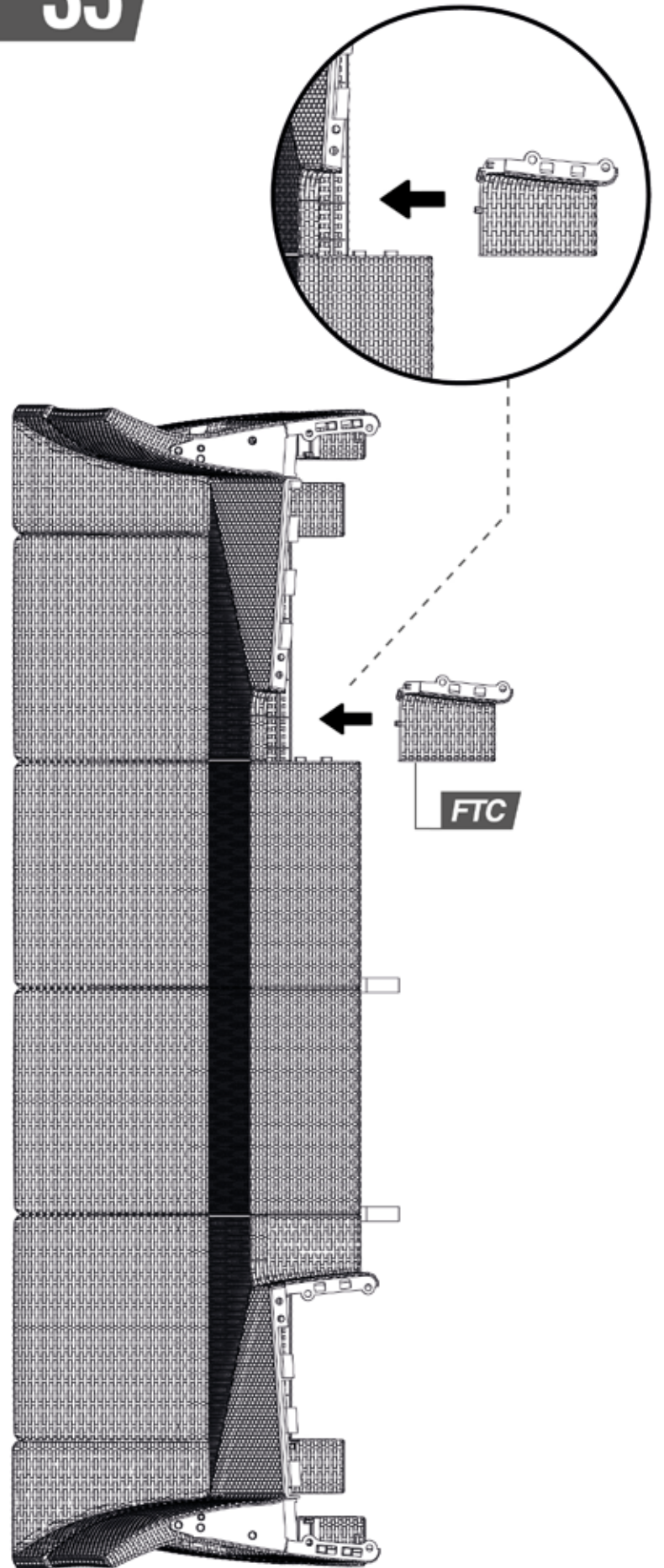



Use the included tool to secure the screws
Utilice la herramienta incluida para asegurar los tornillos

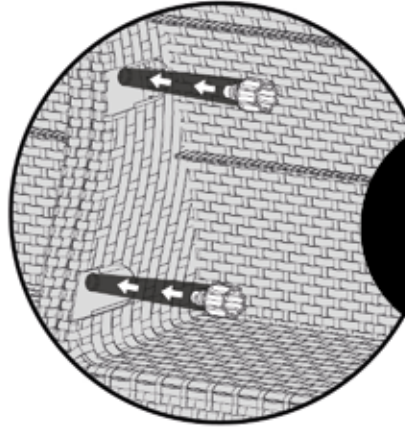
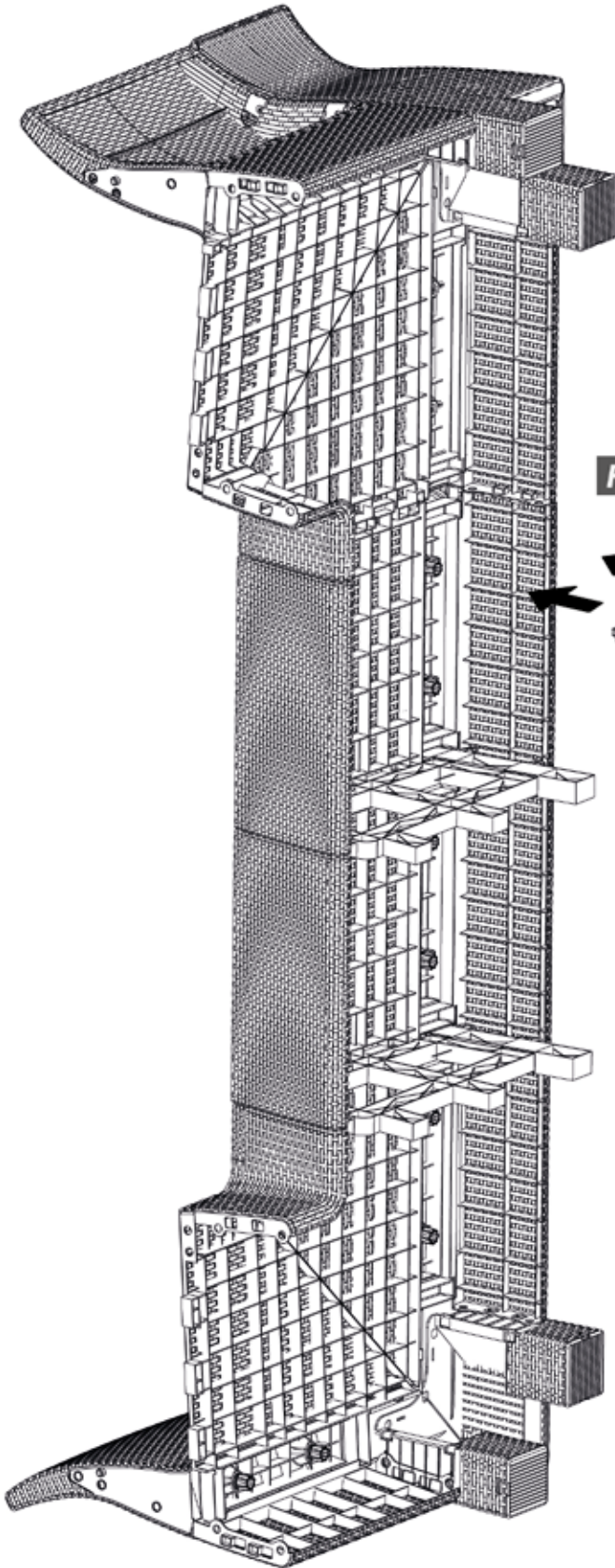

x2

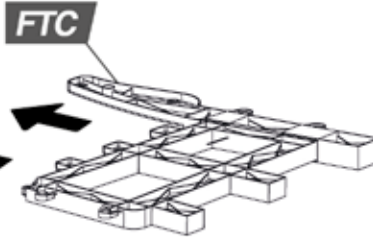

x2

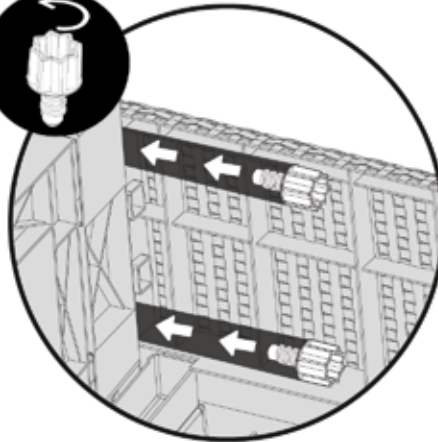

x3

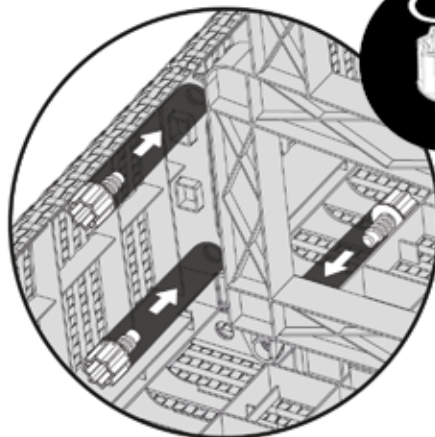

E1	S2	E2
S1		

E1,S2,E2 + S1 SECTION / SECCIONES E1,S2,E2 + S1

STEP / PASO **37**

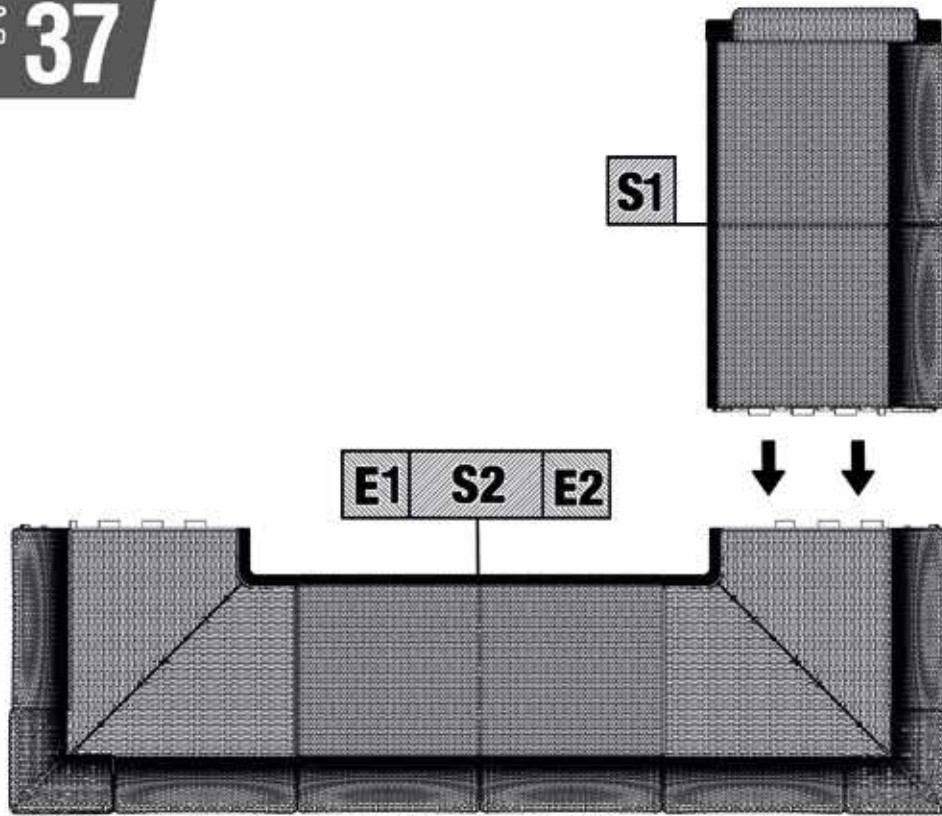

STEP / PASO **38**

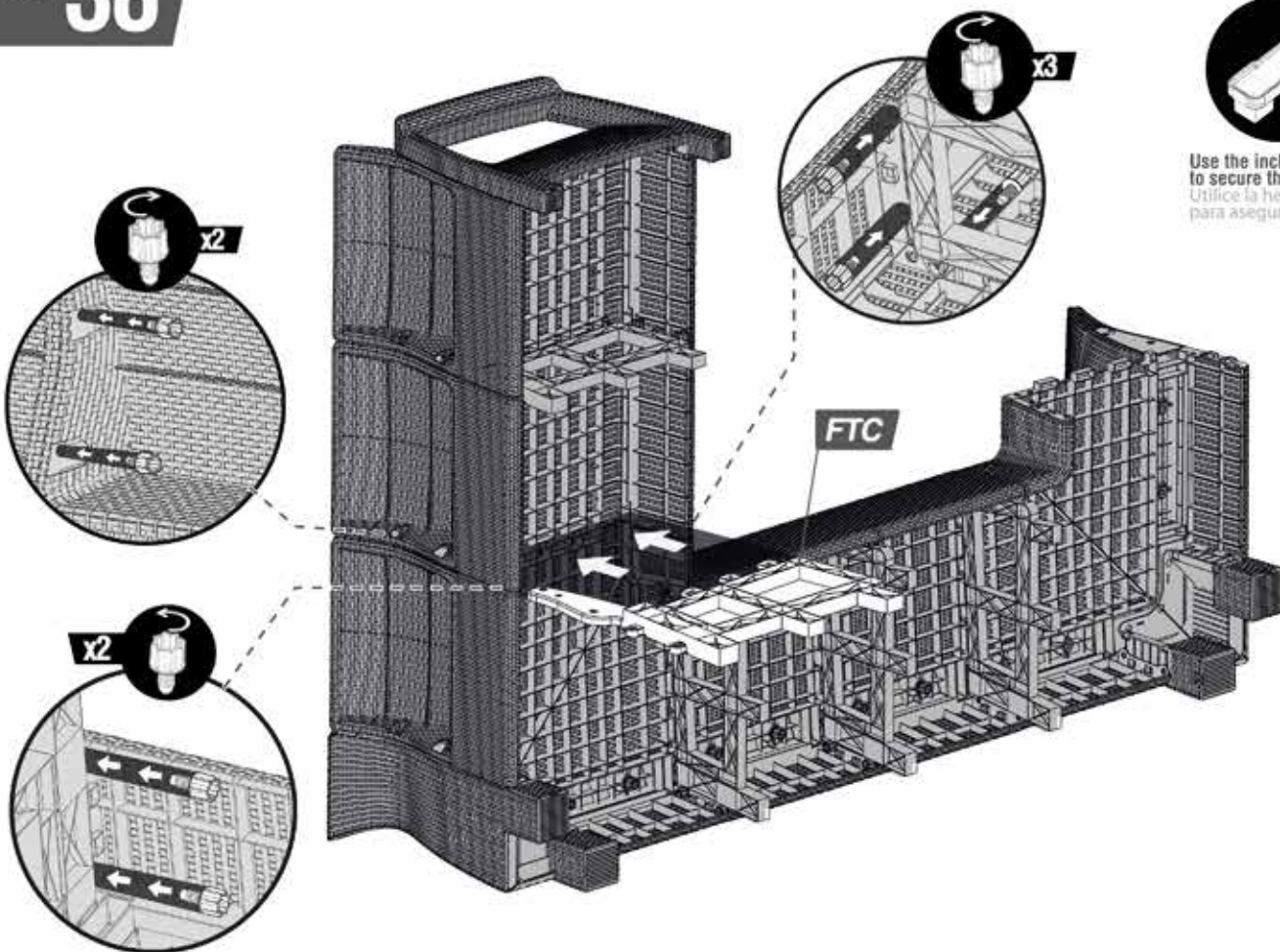

Use the included tool to secure the screws
 Utilice la herramienta incluida para asegurar los tornillos

E1	S2	E2
S1		S3

E1,S2,E2,S1 + S3 SECTION / SECCIONES E1,S2,E2,S1 + S3

STEP / PASO **39**

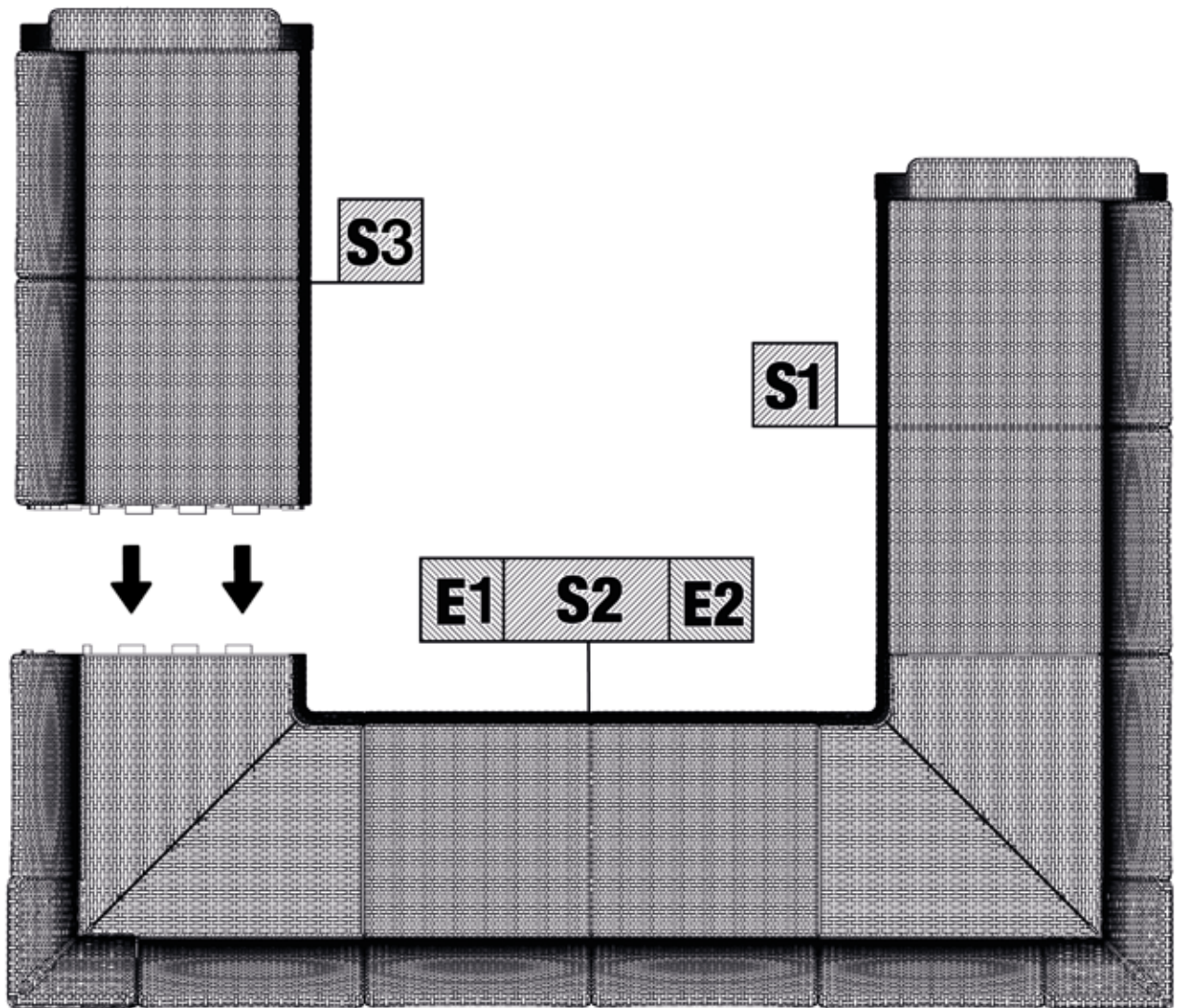

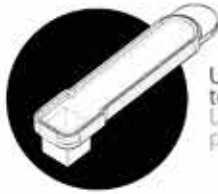

Use the included tool to secure the screws
Utilice la herramienta incluida para asegurar los tornillos

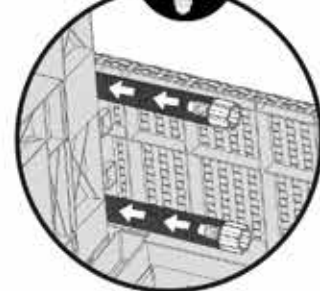
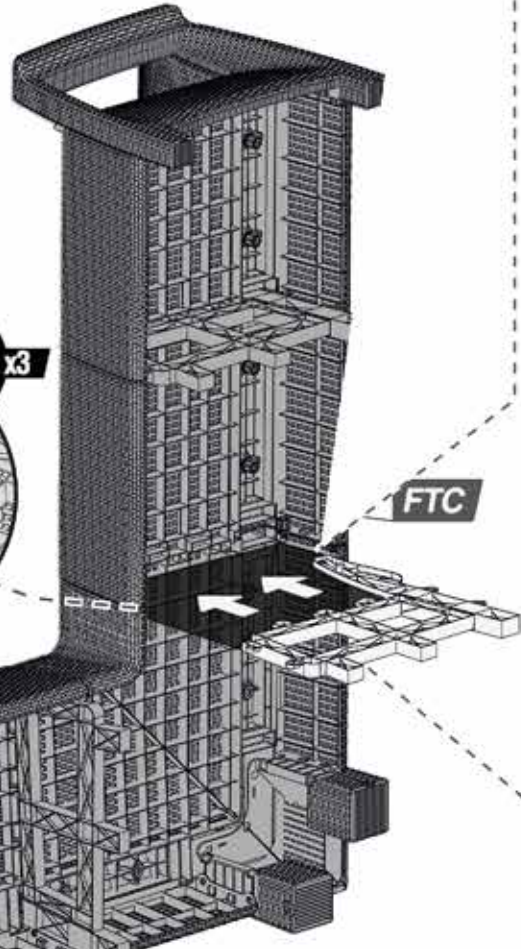
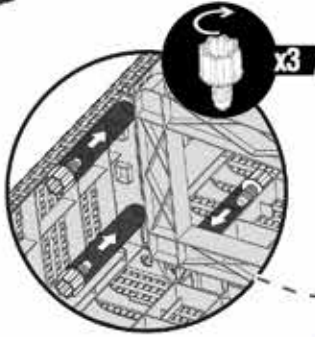

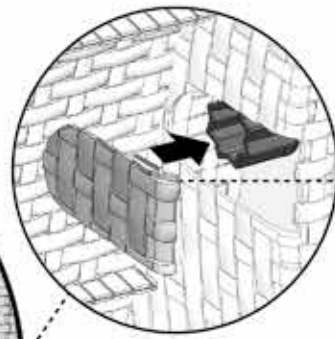
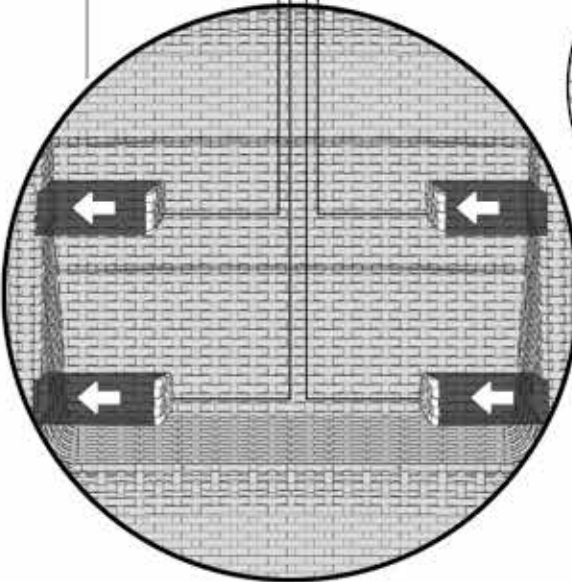
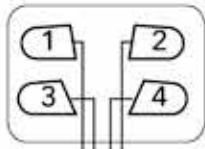
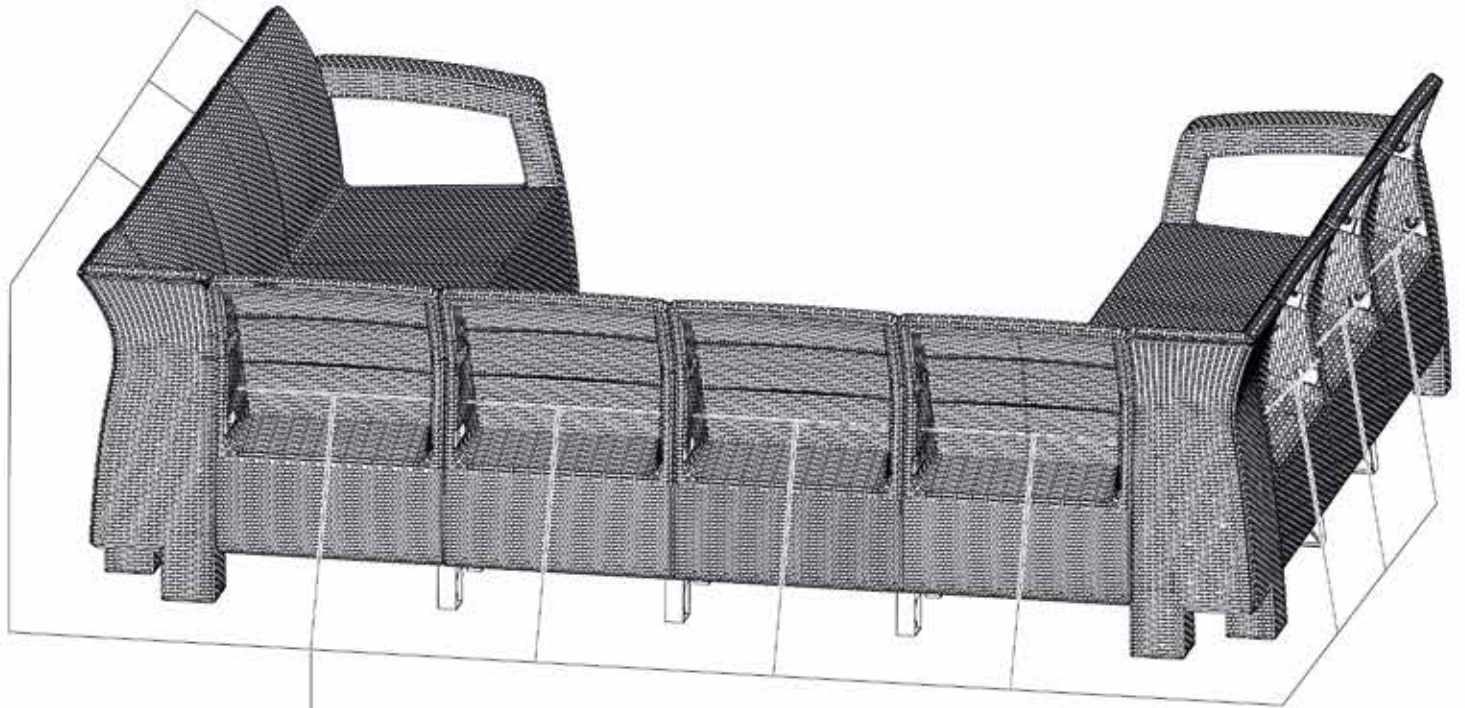

click

NEW NUEVO
ACCESSORY ACCESORIO

2 OPTIONS
OPCIONES

COVER
TAPA

GLASS HOLDER
PORTAVASOS

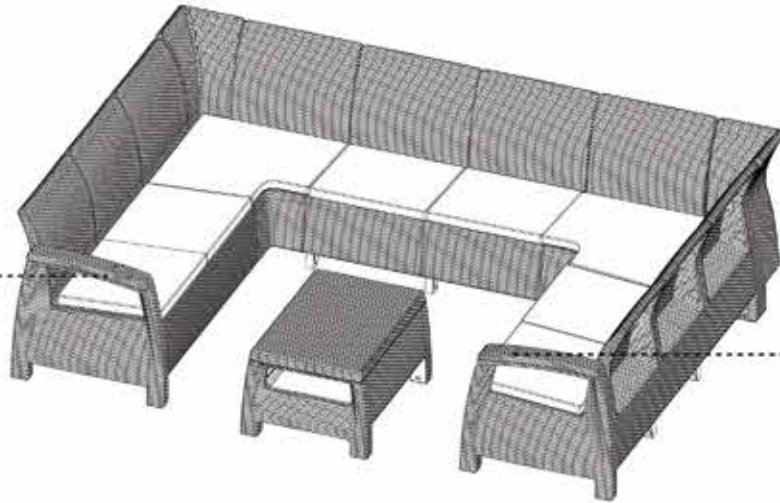

EASY ASSEMBLY
FÁCIL ENSAMBLE

COVER
TAPA

GLASS HOLDER
PORTAVASOS





ASSEMBLY INSTRUCTIONS

INSTRUCCIONES DE ENSAMBLE

FERRARA CENTER TABLE

MESA DE CENTRO FERRARA



/ Assembly Parts / Piezas de Ensamble



LX2

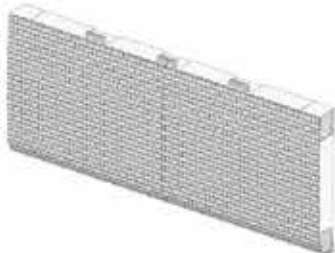

FBX2



CX1

STEP / PASO 1



Lx2



FBx2

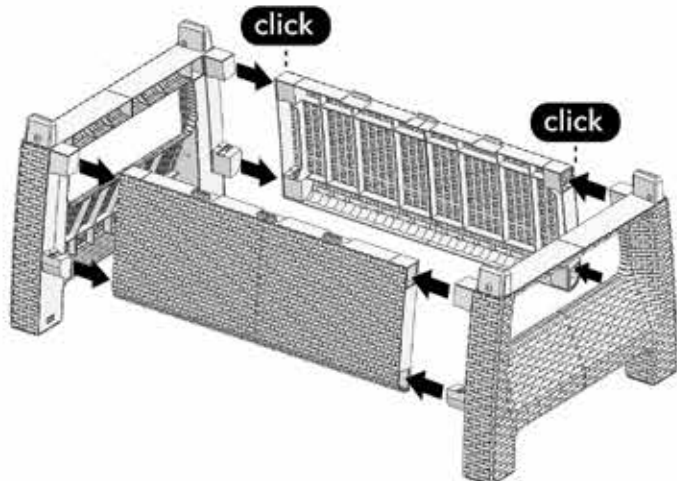

STEP / PASO 2



Cx1

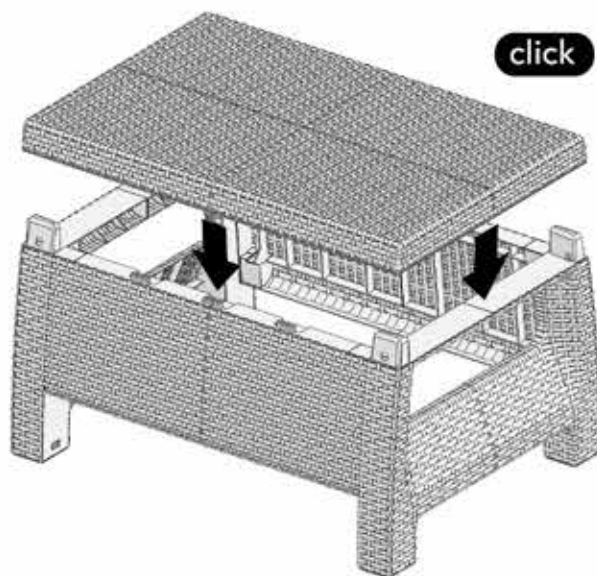

Ferrara Center Table / Mesa de Centro Ferrara

Protegido para Colombia. Patente No. 10463
Protected for Colombia. Patent No. 10463