

Video Version / Versión Video



· C I A P I R I · SILLÓN / CHAIR

| 1 Cushion included | Includo 1cojín

ASSEMBLY INSTRUCTIONS INSTRUCCIONES DE ENSAMBLE

www.plasticosmq.com.co

/ Assembly Parts / Piezas de Ensamble

Required Tool / Herramienta Requerida
*Included / Includa

Screw Wrench
/ LLave para tornillos



x1

Includes 1
replacement screw
Incluye 1 tornillo
de repuesto

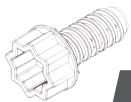

x1

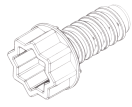

x12



x6

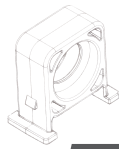

x4



1 x1

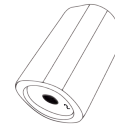

2 x1

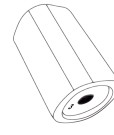

3 x1

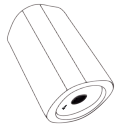

4 x1

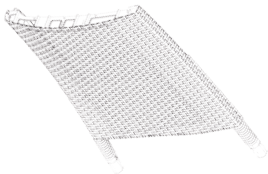

RA x1



RA-CO x1



LA x1



LA-CO x1

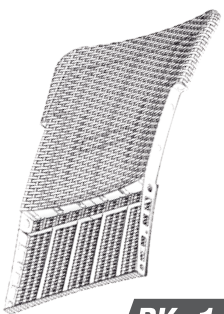

BK x1

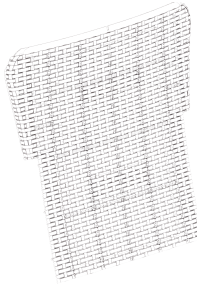

BK-CO x1



SE x1

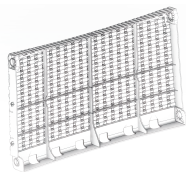

FB x1

STEP
/ PASO

1

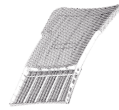

BK x1



SE x1

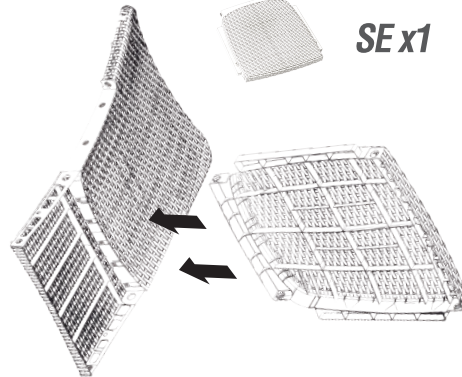

STEP
/ PASO

2

FB x1

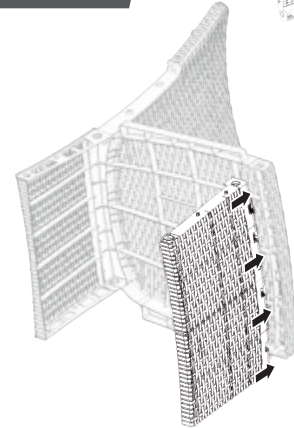

STEP
/ PASO

3



x1



x3



x2

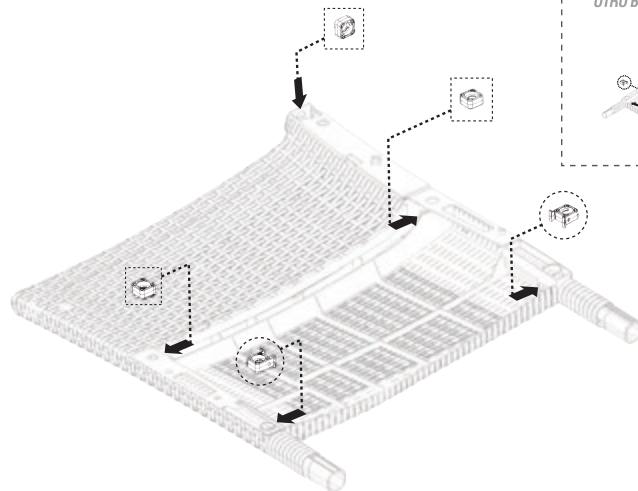

REPEAT THIS STEP WITH THE
ANOTHER ARM OF THE CHAIR
REPITE ESTE PASO CON EL
OTRO BRAZO DEL SILLÓN

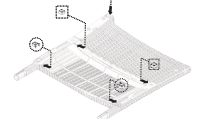

STEP / PASO

4

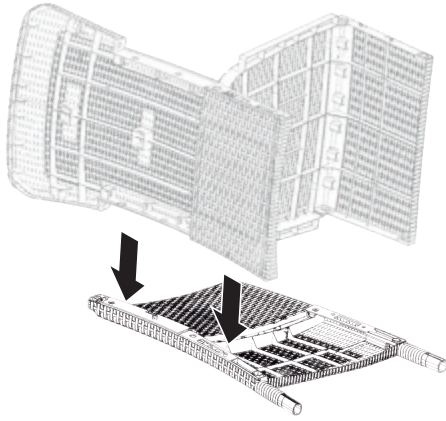

STEP / PASO

5

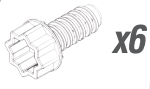

Use the included tool to secure the screws
Utilice la herramienta incluida para asegurar los tornillos

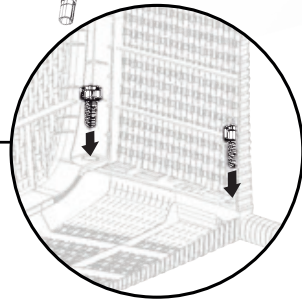
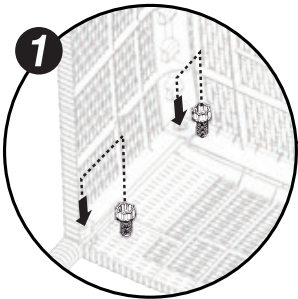
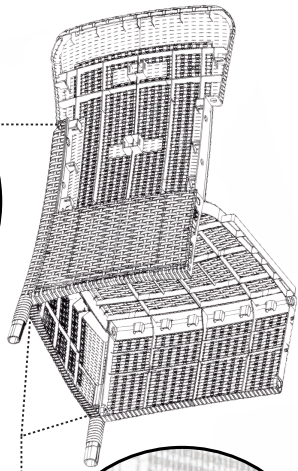
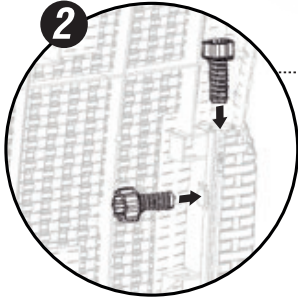

STEP / PASO

6

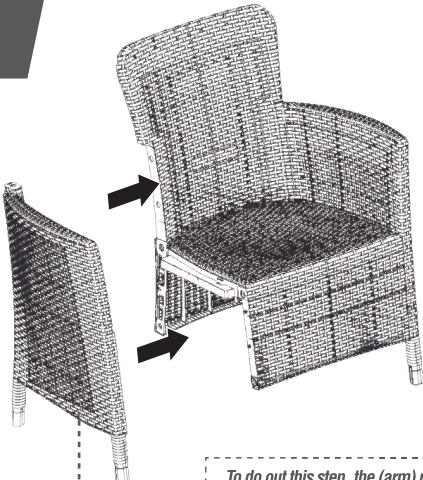

To do out this step, the (arm) piece must be pre-assembled from step 3
Para realizar este paso la pieza (brazo) debe estar pre-ensamblada desde el paso 3

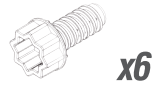

STEP / PASO

7

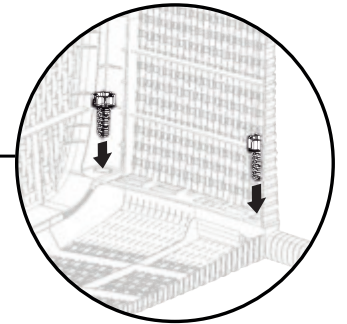
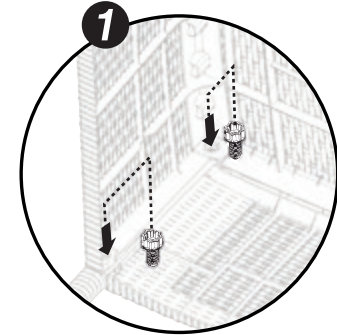
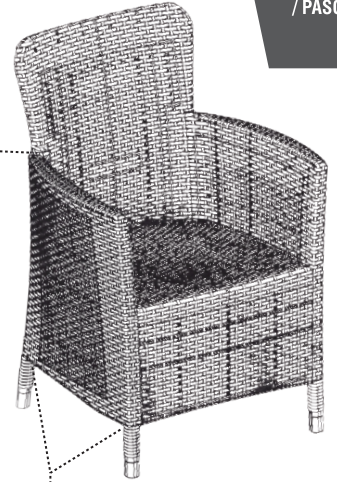
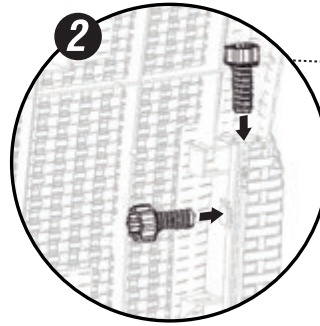

STEP / PASO

8

click

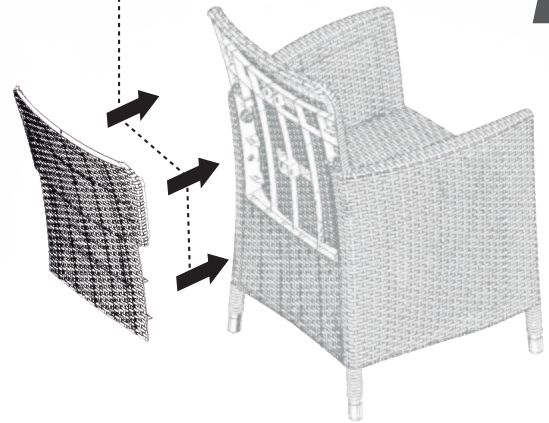

STEP / PASO

6

Check the identification number
Verifique el número de identificación

1-2-3-4



STEP / PASO

9

